

SMT Adviser
Kazuo Kawai
E-mail:jitusougiken@ybb.ne.jp

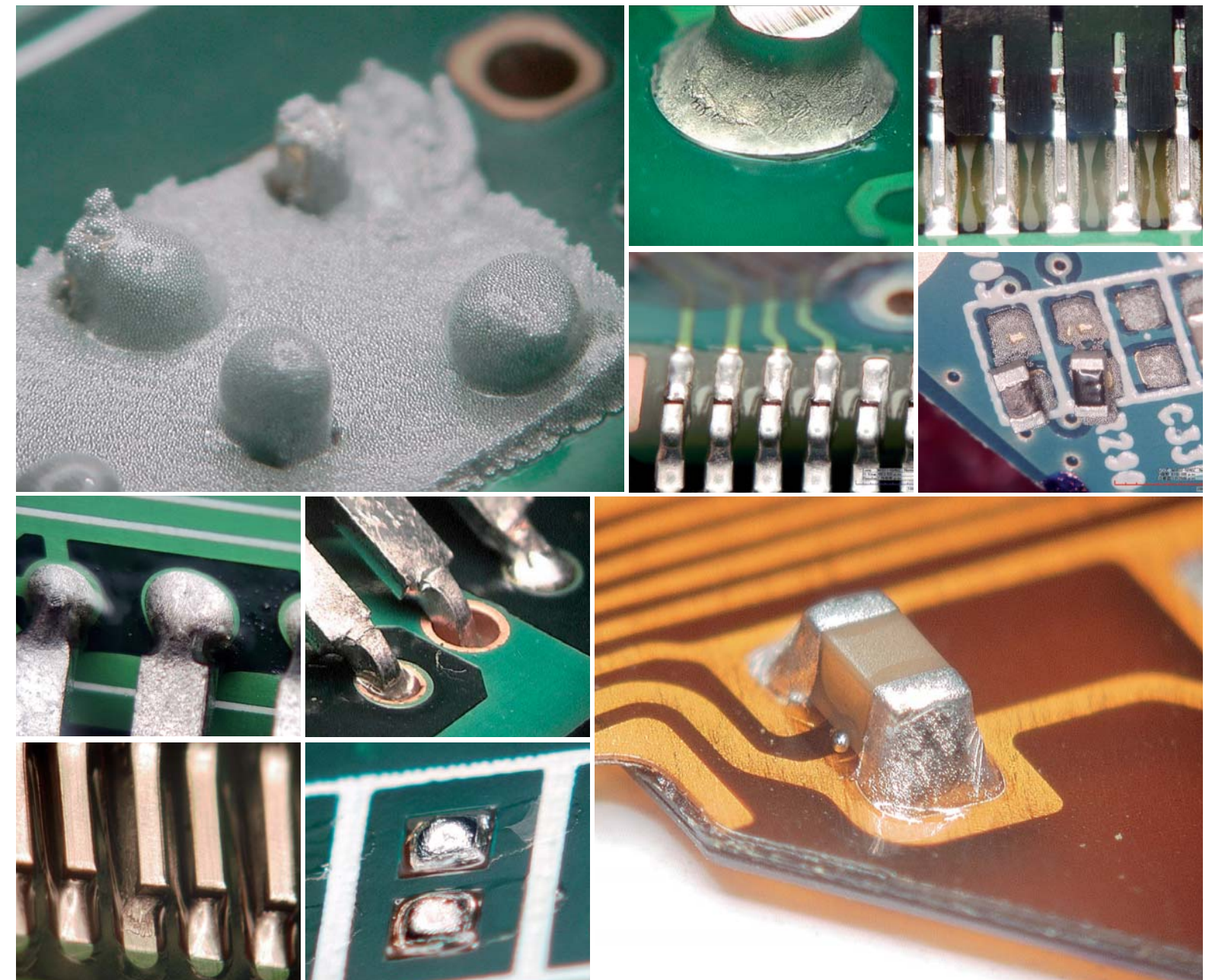

Hirox-USA Inc. Tel:(201)342-2600 Fax:(201) 342-7322 Toll-Free:(866)HIROX-US
1060 Main Street, River Edge,NJ 07661
<http://www.hirox-usa.com> E-mail:info@hirox-usa.com

Hirox Co.,Ltd. <http://www.hirox.com>
2-15-17 Koenji Minami,Suginami-ku,Tokyo166-0003,Japan
Tel:(+81) 3-3311-9911 Fax:(+81) 3-3311-7722 E-mail:tokyo2@hirox.com

Hirox China Co.,Ltd. <http://www.hirox.com.cn>
Room 809, 8th Floor, Fortune International Plaza, No.43 Guo-Quan Road, Shanghai 200433, China.
Tel: +86-21-6564-7772 Fax:+86-21-3362-5017 E-mail:info@hirox.com.cn

Hirox Korea Co.,Ltd. <http://www.hiroxkorea.com>
#719 Metrokhan Bldg, 1115 Bisan-dong, Dongan-ku, Anyang-city, Gyeonggi-do,431-058, Korea
Tel:+82-31-385-1130 Fax:+82-31-385-9730 E-mail:bgkim@hiroxkorea.com

Hirox Asia Ltd. <http://www.hirox-asia.com>
Suite 1213, 12/F, Ocean Centre, 5 Canton Road,Tsimshatsui, Kowloon, Hong Kong
Tel:+852 8198-9679 Fax: +852 3015-7657 E-mail:info@hirox-asia.com

Hirox Europe <http://www.hirox-europe.com>
Jyfel, 8 Place Bellecour 69002 Lyon, France
Tel:+33 970 44 59 50 Fax:+33 4 26 23 66 77 E-mail:info@hirox-europe.com

■Contact us

The items described in this pamphlet may be changed without notice.

3D Digital Microscope

Now You can See!

As a pioneer of image observation,
we have produced a digital microscope that provides answers.
It has evolved from a "machine" that simply observes to a "partner" for the observer.



Contents

I) Reflow	2
1) Temperature profile	2
2) Self-alignment effect	3
3) Reflow of applied solder	4
4) Reflow of through-through-hole components	5
Examples of soldering failure	6
5) Flux properties	7
6) Operation of reflow oven and its characteristics	9
(1) Selection of a reflow oven	9
(2) Thermal transfer	9
(3) Mounting BGAs	10
(4) Voids	11
(5) Chip-side solder balls	13
(6) Mounting 0402 chips	14
(7) Failure in plating on component leads	14
II) Flow	15
1) PCB angle to solder bath	15
2) PCB design error	17
3) Temperature setting point	17
III) Touch-up and Rework	18
1) Solder surface	18
2) Soldering iron tip	18
3) Rework	19
4) Handing failure	19
(High-temp. flux residue and failure)	
IV) Inspection Process	20
1) Observation and remedies	20
(1) Lack of heat	20
(2) Land stripping	20
2) Inspection angle	21
3) Whiskers	22
4) Other failures	22
V) Design	23
Summary	24
Sources of information	24
Digital Micro Scope	24

I) Reflow

1) Temperature profile

One of the key factors of reflow oven is preheating. The preheating of a component and PCB is basically the same in leaded and lead-free soldering. Preheating is the range from room temperature to the melting point of solder.

Wettability of solder is influenced by the properties of flux contained in solder as well as the length of time between room temperature and melting point of solder. Most solder failures occur at the melting point. Therefore, a moderate gradient from room temperature to the melting point is a remedy for preventing many solder failures.

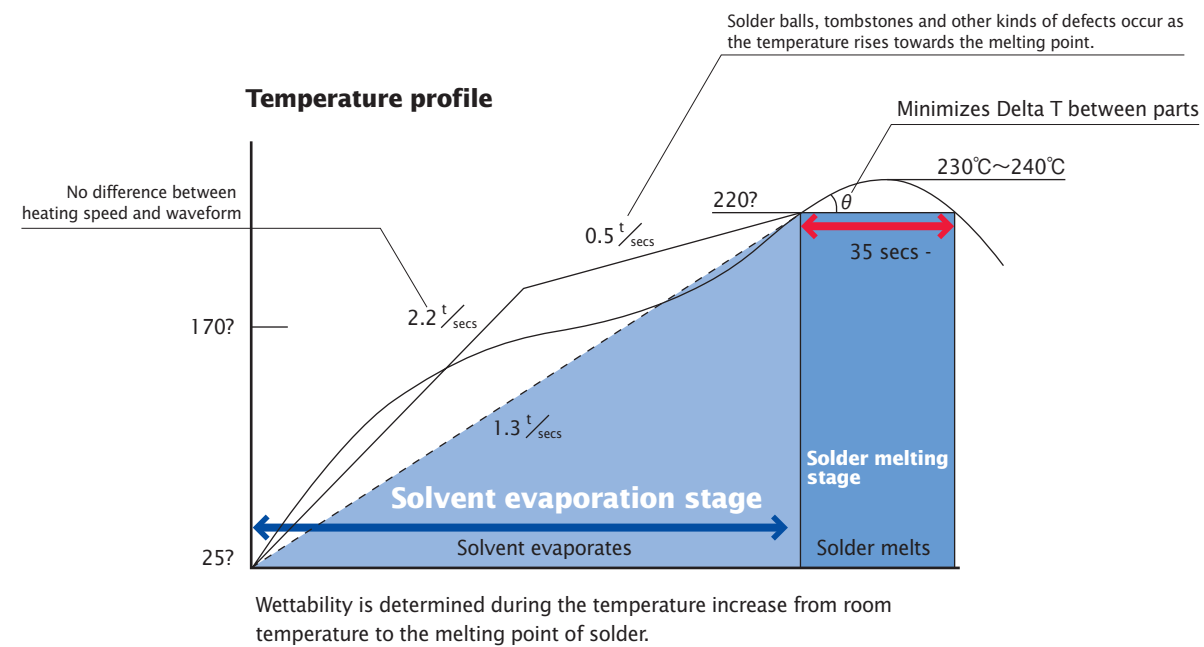

Preparation of temperature profiles

Solder does not wet unless it melts. Therefore, the temperature difference between leads (Delta T) should be minimized within the tolerance range during solder being melted, but not necessarily during the pre-heat stage. Minimizing Delta T in the pre-heat stage can lead to a greater delta T within a solder melting temperature, possibly resulting in longer heating or stronger convection, a direct cause of flux burnout and thermal stress on PCBs and components.

Recap: Delta T must be minimized during solder melting phase (as shown with red arrow) but not necessarily pre-heating (as shown with blue arrow).



Picture 1: Spattered flux residue may cause poor wetting or create voids.



Picture 2: Normal flux residue as a result of proper flux activation to heat between land and leads.

Flux reacts with heat first on an entire mounted PCB. Under the normal profile, flux reacts on component leads. Thus, observation of residual flux is important.

Residual flux (Picture 1) spattered by strong convection and (Picture 2) residual flux after adjustments of air flow.

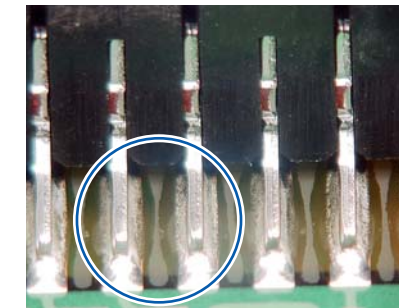

Picture 3: Solder with no bridges.

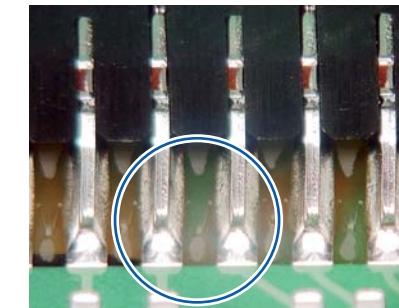

Picture 4: Solder with bridges due to wrong profile or flux activation.

Picture 3: Flux properly reacts to heat on component leads. Solder spreads as normal and prevents bridges.

Picture 4: Wrong profile causes deterioration of flux and leads to solder bridges between leads. Bridges and voids occur as flux improperly moves while the solder melts.



Picture 5

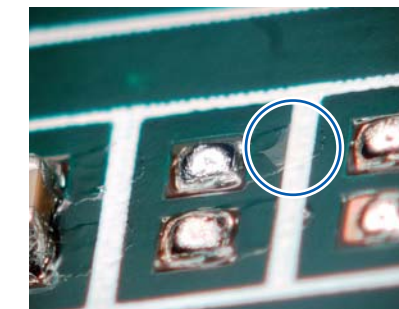

Picture 6

Flux moves while reacting to heat on lands. Melted solder shifts to the area where flux moves. Components shift with solder and stay on the lands.

2) Self-alignment effect

If the temperature profile is appropriate and matches the flux properties, bridging and mis-alignment will not occur due to lead-free solder's strong self-alignment characteristics.

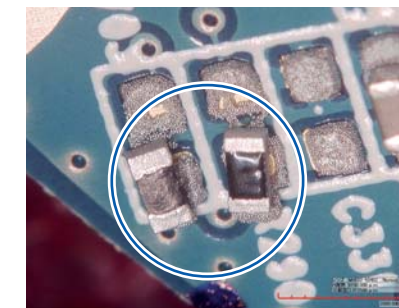

Picture 7

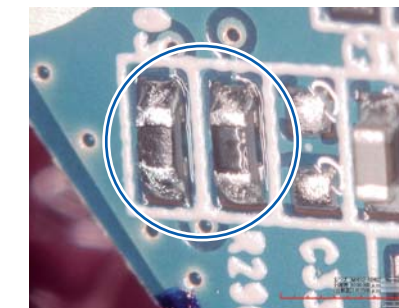

Picture 8

Components are intentionally shifted after mounting and reflow. Due to self-alignment nature of lead-free solder, all components are positioned normally on the lands through the reflow process.

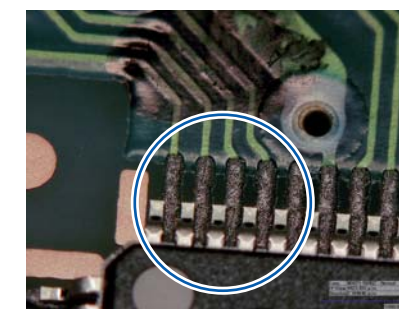

Picture 9

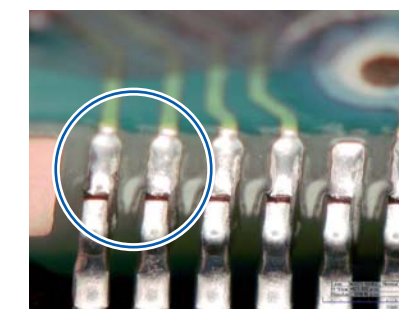

Picture 10

Shifted QFP is re-positioned because of self-alignment effect.



Picture 11



Picture 12

Even with a good temperature profile, self-alignment will not occur if there is insufficient solder printed. A proper amount of solder is required to take advantage of the self-alignment effect.

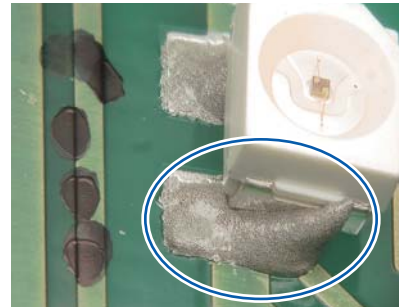

Picture 13

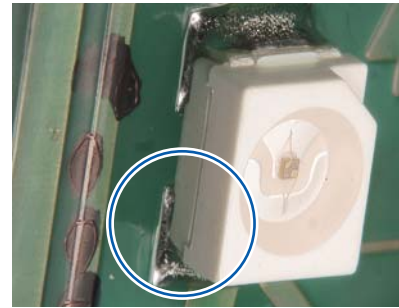

Picture 14

3) Reflow of applied solder

Instead of manual application, solder can be applied by reflow due to the cohesive nature of lead-free solder.

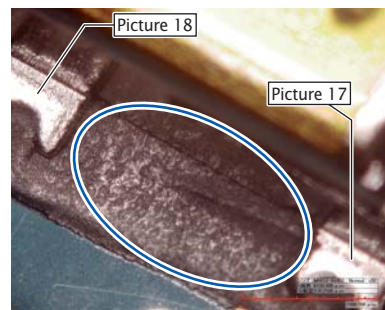

Picture 15



Picture 16

Printing solder on resist
Solder on resist area flows and coheres to component leads as shown in pictures 17 and 18.
During mass-production, aperture (shown with red line) allows a consistent solder print.
Printing high volumes using a mask opening (as shown in the red dotted line) is more reliable than applying solder by hand.
The key point for good printing is to print the solder thin and wide to the resist line in order to allow sufficient heat transfer.

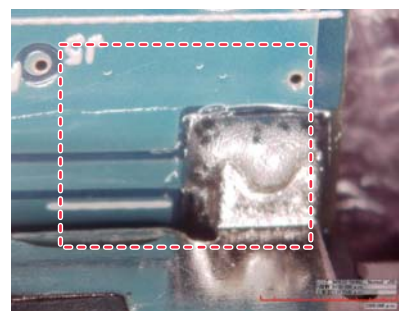

Picture 17

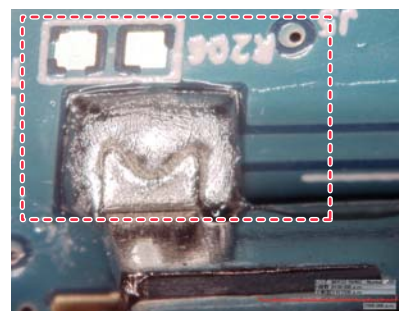

Picture 18

4) Reflow of through-hole parts

Through-hole parts can be done by reflow. Reflow minimizes soldering inconsistencies that often occur with a manual soldering process. The use of reflow instead of flow is environmentally friendly and improves cost performance and quality.

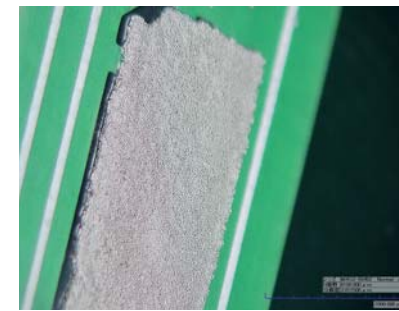

Picture 19: Bold printing on 4-layer substrate

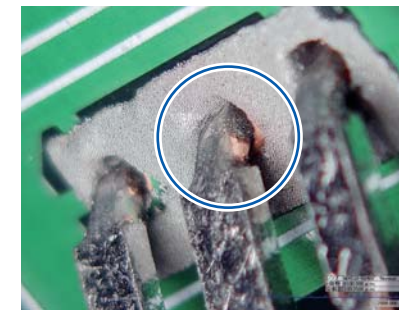

Picture 20: Insertion of leads from printed side

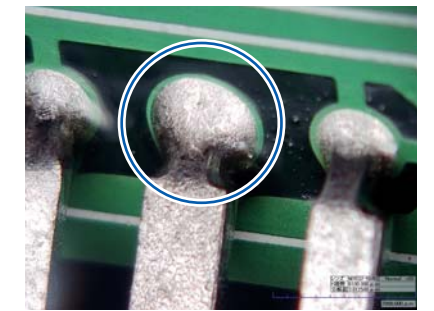

Picture 21: No bridges after reflow

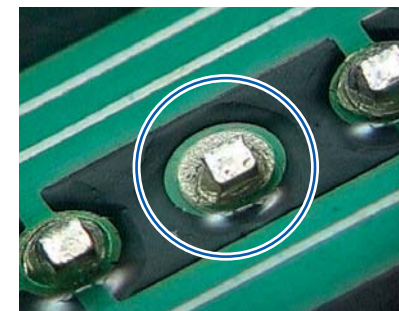

Picture 22: Good back fillet.

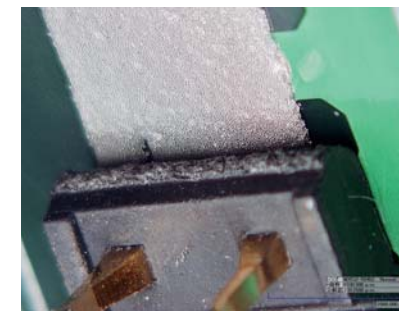

Picture 23: Insertion of leads from printed side

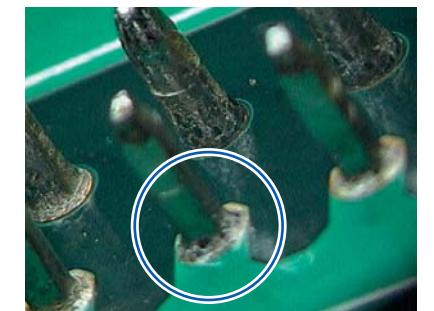

Picture 24: Fine wetting on leads

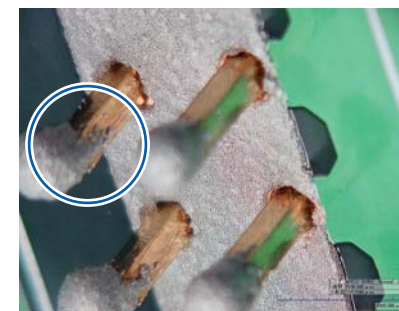

Picture 25



Picture 26

Selection of solder and printing conditions are key factors to determine solderability.
Residual flux found on both sides of the through-hole is an indication of good soldering.
No bridges despite leads inserted from the bottom side. (Pictures 26 and 28)

(Pictures courtesy of Yuyama Co. Ltd.)



Picture 27: Solder reacts to heat on leads and no bridges are formed despite bold printing.



Picture 28: Residual flux stays on printed area of solder paste.

Printing side and insertion direction of leads are at manufacturer's discretion. Thin and well-spread solder printing allows flux to react to heat. Flux needs to react to heat quickly and stay within the printed area.

(Kojima Solder used in the pictures)

Examples of incorrect soldering

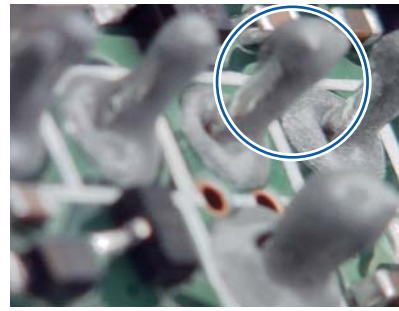

Picture 29



Picture 30

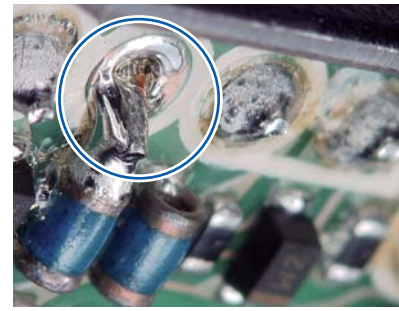

Picture 31

Combining the printed solder with the land increases thickness, resulting in slower heat reaction and a higher risk of bridge formation.



Picture 32



Picture 33

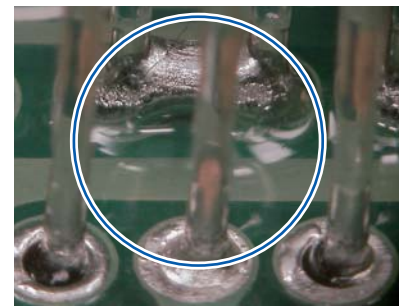

Picture 34

Using higher temperature resistant flux causes spattering. The selection of solder (flux) is extremely important in order to prevent bridges from forming and/or insufficient solder which can cause voids to occur more frequently.

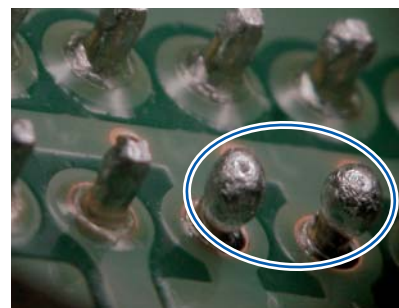

Picture 35

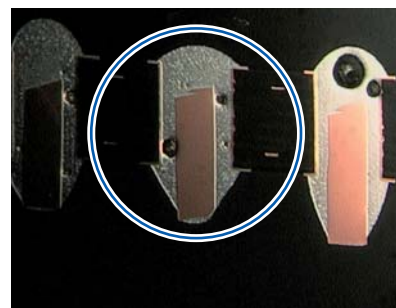

Picture 36

Long leads have a high convective flow that reduces the risk of voids.

5) Flux characteristics

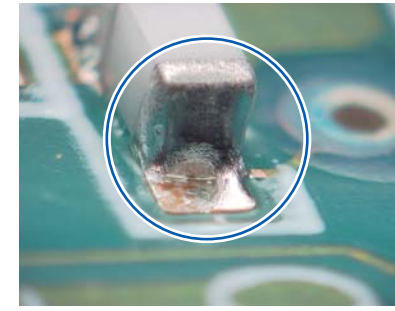

Picture 37



Picture 38

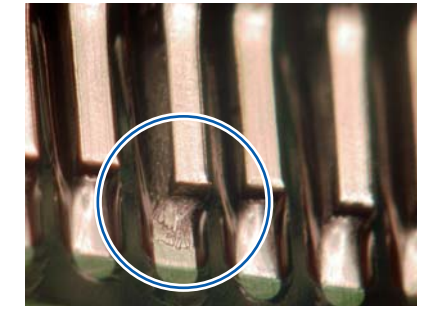

Picture 39

The temperature at the tips of the leads is lower due to the solder melting temperature and the flux vaporization overlapping, and/or the residual high temperature resistant flux repelling the solder.



Picture 40



Picture 41



Picture 42

In these pictures of solder and residual flux on an FPC, there is a significant amount of residual high temperature resistant flux. This leads to voids on the bottom of fillets. (Pictures courtesy of Yuyama Co. Ltd.)



Picture 43



Picture 44

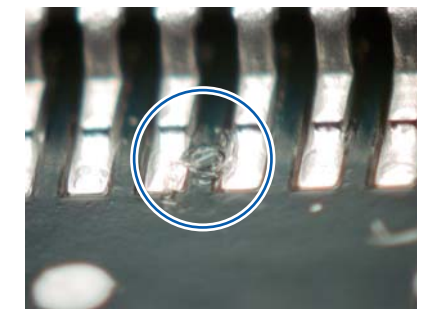

Picture 45

Although they look like fibers or hair, these pictures show residual flux. The location of this phenomenon cannot be specified.

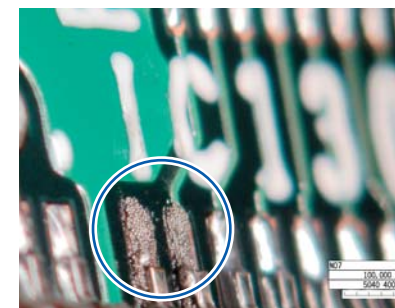

Picture 46

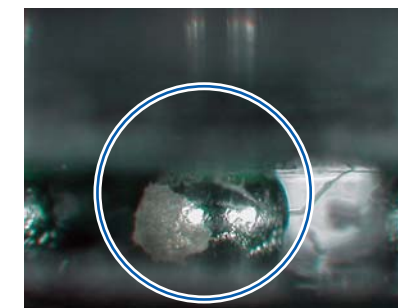

Picture 47

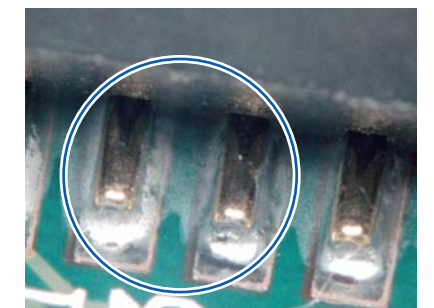

Picture 48

Some of the solder oxidizes and does not melt because of spattering flux. This leads to voids on the bottom of the BGA.



Picture 49: Company A



Picture 50: Company B

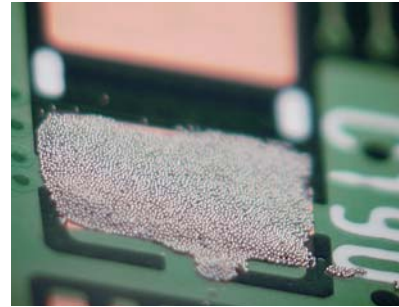

Picture 51: Company A



Picture 52: Company B

Solder is printed on the FPC resist, quickly connected and placed in the oven. When the first FPC leaves the oven, the oven is turned off, the cover opened and the FPC removed.

At this point, the order of the oven heating elements, the temperature profile and the FPC order are recorded. The spattering of solder and flux is checked afterwards.

The photographs show that a significant amount of temperature resistant flux did not evaporate and remain on the FPC and around the solder. If the heat is not properly balanced, this causes voids on the bottom of the fillet.(Picture 50,51,52) This is also true for a rigid circuit board. Solder from Company A(Picture 49,51) on the board does not melt, but solder from Company B(Picture 50,52) has melted. Even if the metals are the same, different flux (solvents, etc.) have different melting points. Solder from Company A requires higher temperatures and is not appropriate for parts or boards with low temperature resistance.

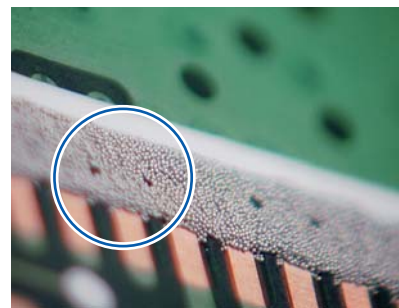

Picture 53

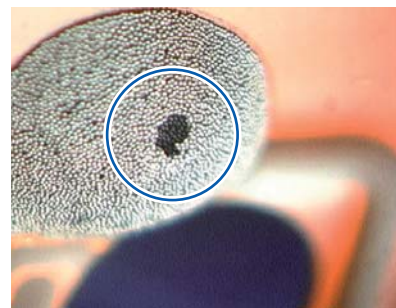

Picture 54



Picture 55

Pictures 53 and 54 show traces of spattered solvent in the 4th zone of the reflow oven and traces of depressions left by spattered flux.(Picture 55)



Picture 56



Picture 57



Picture 58



Picture 59

Residual wire solder using high temperature resistant flux and blowholes.

Using lead-free solder requires working at even higher temperatures, which also require the use of high temperature resistant flux.

This creates a cycle requiring higher heating capacity of equipment and tools. Using higher temperature resistant flux has an effect on quality in areas that are not directly visible. This means that production facilities need to re-evaluate their systems for observing and monitoring soldering quality.

The KH-7700 digital microscope from Hirox can observe from any angle by rotating the tip of the lens and is perfect for visual inspections at factories. Automated visual inspection machinery alone is not sufficient for determining how to improve production processes.

All of the pictures in this pamphlet were taken with the KH-7700 or KH-1300 digital microscopes from Hirox.

6) Reflow oven properties and methods of operation

(1) Selecting a reflow oven

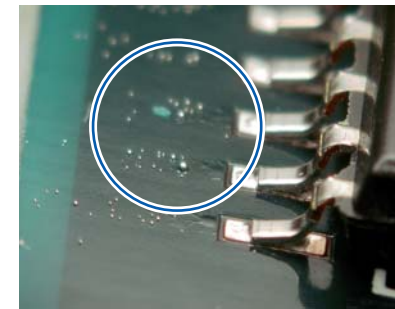

Picture 60: Convection reflow oven

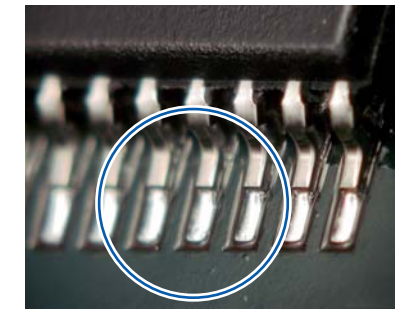

Picture 61: IR and Convection reflow oven

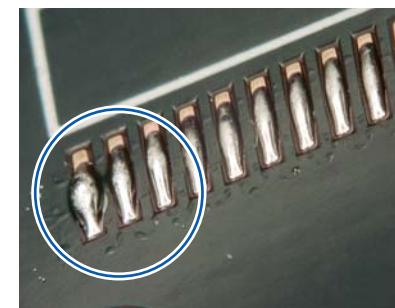

Picture 62: Convection reflow oven

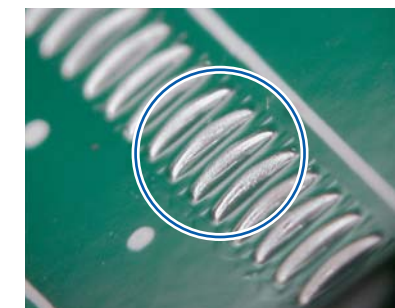

Picture 63: IR and Convection reflow oven

Heat flows to the interior layers of multi-layered boards. To prevent this, infrared heaters are used to heat the boards themselves and reduce air movement. Then heat is supplied to the leads with an air heater to melt the solder.

With convection ovens, fans are used as little as possible during preheating and adjustments must be made to lengthen the main heating time of the profile.

Strong air flow has a large impact on the heat of the board and the parts. Low air flow with high temperature resistant flux can result in voids and insufficient heat.

When using IR and convection reflow ovens, IR on the bottom of the oven is set high to heat the boards themselves while the heating elements on the top control the melting of solder.

A strong fan in a convection reflow oven causes flux and solder to spatter.(Picture 60,62)

(2) Transition of Heat

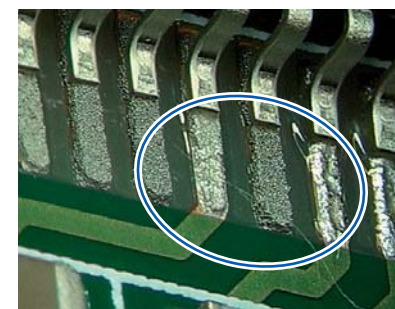

Picture 64: Using only a bottom heater, heat from the pattern melts the solder.

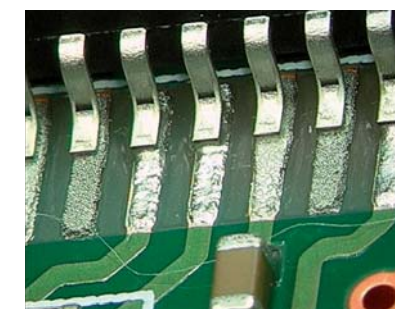

Picture 65: Solder did not flow properly due to lack of heat supply caused by unconnected patterns of the lead position

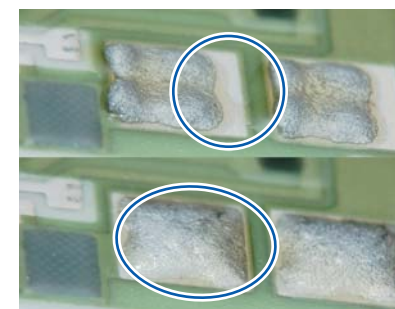

Picture 66: The top is a normal profile while the bottom is the result of the bottom heater being 10 degrees too high.



Picture 67: Heat dissipation from the pattern during manual soldering creates good gloss on the fillet.

Even though the IR heater on the bottom does not provide heat directly to the components, heat from the board passes through the pattern and concentrates around the bottom of the land and partially melts the solder.(Picture 64,65)

The opposite is true with robot soldering. Heat escapes from the pattern and immediate cooling creates good gloss on the fillet.(Picture 67) Also, since flux deteriorates quickly on ceramic boards, solder wetting is achieved by heat from the bottom heater causing the flux to spread to the land first.(Picture 66)

Although hot air from air reflow causes the flux to deteriorate first, wide wetting can be achieved without flux deterioration by using the effects of floor heating from the IR heating element.

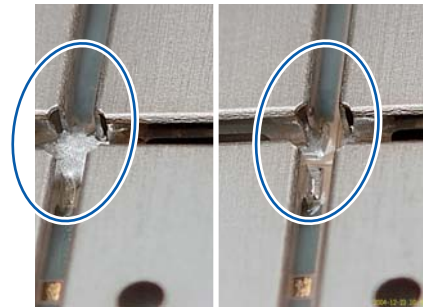

Picture 68: The left half is a normal profile and the right half is with the bottom heater set high.

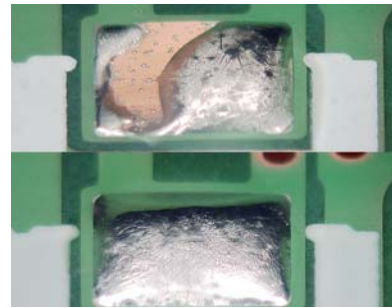

Picture 69: Peak temperature of 270 degrees

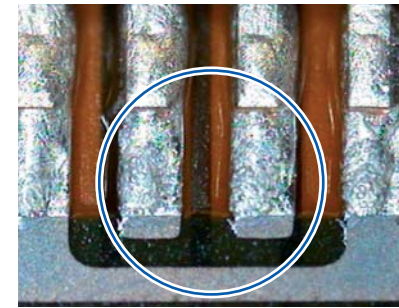

Picture 70: Peak temperature of 270 degrees



Picture 71: Peak temperature of 255 degrees

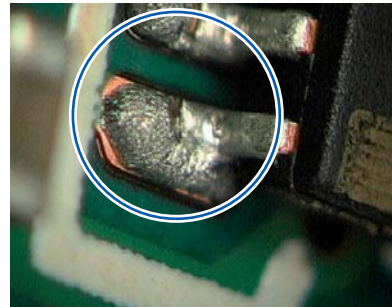

Picture 72: Un-melted solder caused by fan speeds set too high.

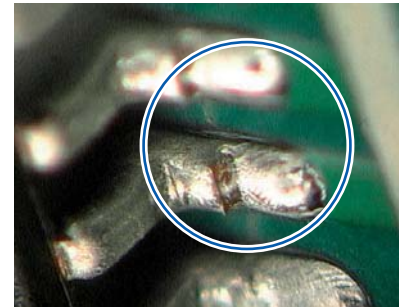

Picture 73: Solder melts and flux deterioration is controlled using a low-speed fan.

Thick solder bridges and un-melted solder occur even after a strong flow of heated air is added in a short period of time due to flux deterioration and the oxidation of particles. The upper heater is appropriately set to melt the solder. More important is preventing the deterioration of flux and solder particles during the preheating stage. Strong air flow during preheating works like an electric fan, causing flux deterioration and oxidizing solder particles, which inhibits melting. Controlling heated air in the preheater allows the solder to melt, even with a lower temperature.

(3) Mounting of BGAs

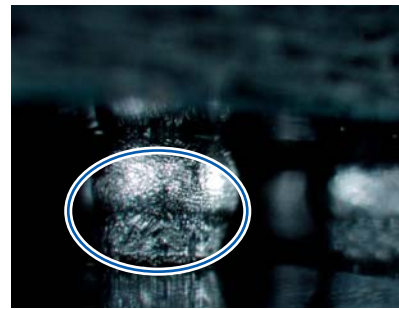

Picture 74: Insufficient wetting due to flux deterioration

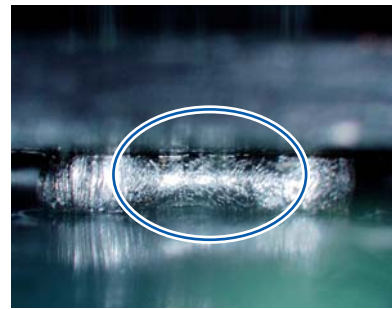

Picture 75: Bridge

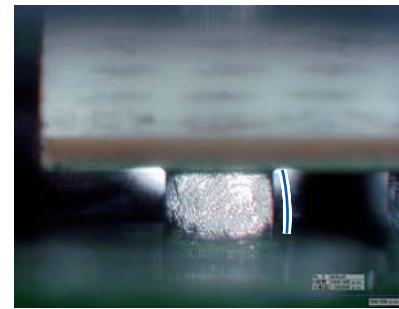

Picture 76: Overheating causes the ball to expand

Even with BGA's, if the upper heaters are set too high, oxidation of the ball exterior and deterioration of flux and the components occur and can result in warped bridges and potato-shaped solder.

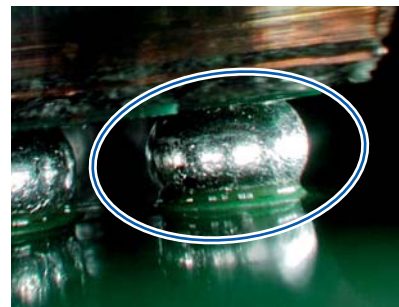

Picture 77: Using N2

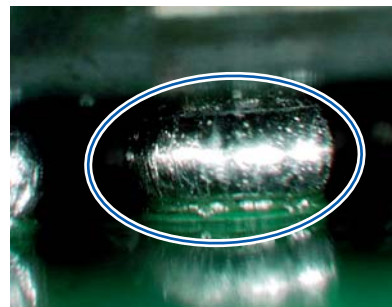

Picture 78: Convection reflow using solder from Kojima Solder

Halation on the center of the solder ball shows horizontal straight joints, proving that the ball has a good spherical shape. Wettability can be effectively achieved by selecting a profile that suits the characteristics of the solder flux used with N2. If you review the preheating process, you can eliminate the use of N2 by setting the temperature of the bottom heater 20 degrees above the upper heater. By using the bottom heater, you can achieve good wettability without using N2.

(4) Voids

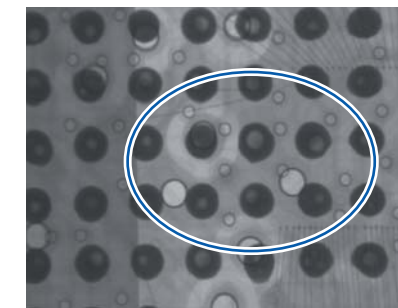
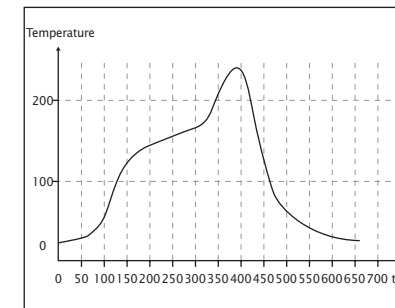

Picture 79

Long profiles cause flux to deteriorate, creating voids.

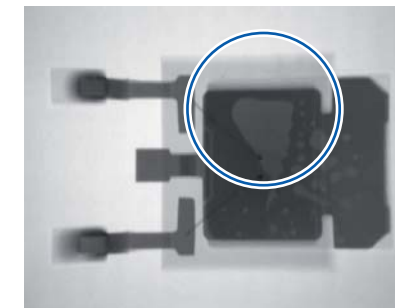

Picture 80: Normal profile

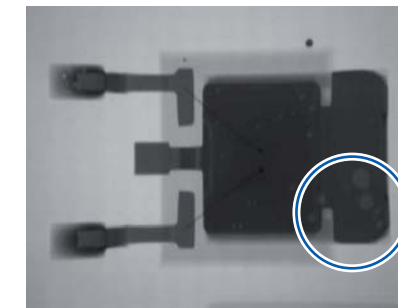

Picture 81: Compact profile

Using an IR oven on the bottom helps reduce voids; a common problem with BGA.

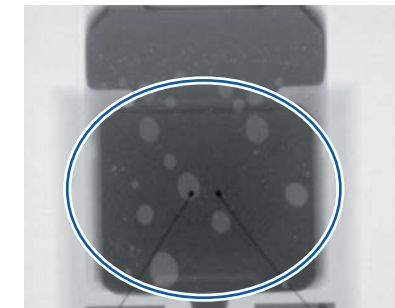

Picture 82: Convection reflow

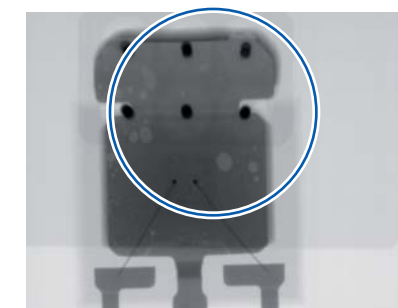

Picture 83: IR and convection oven

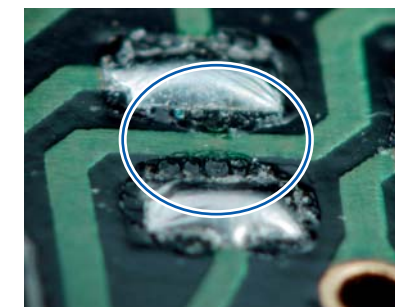

Picture 84: Air bubbles from paper phenol

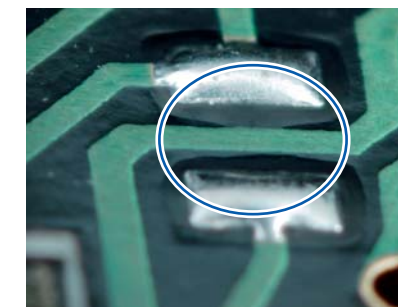

Picture 85: Improvements made possible by speeding up the conveyor belt.

Long profiles or convection reflow leaves voids on the interior of the fillets due to deteriorating flux and gases emitted when the flow of solder is poor.

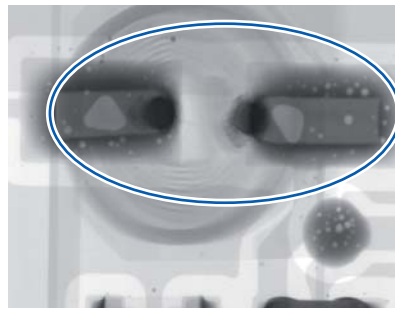

Picture 86

Gas does not bleed well from components such as aluminum electrolytic capacitors. Making the lands bigger to facilitate the release of gas from these parts with solder convection helps to alleviate this problem.



Picture 87: Replaced with bigger land

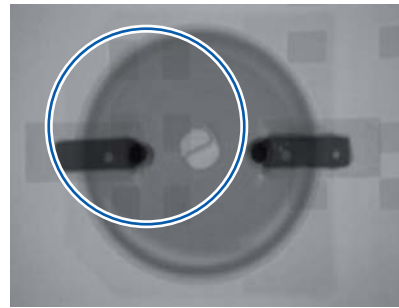

Picture 88: Sample from Picture 87 observed through X-Ray

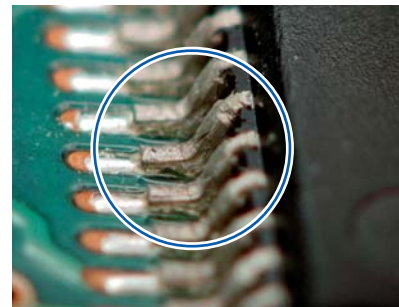

Picture 89



Picture 90

After 1000 heat cycles, the solder on the leads has been strongly affected by heat. However, the effect of heat on the front fillet is hardly visible, thanks to the release of heat from the land surface.

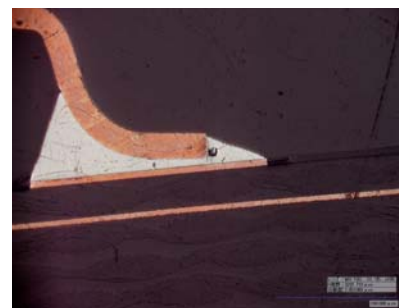

Picture 91

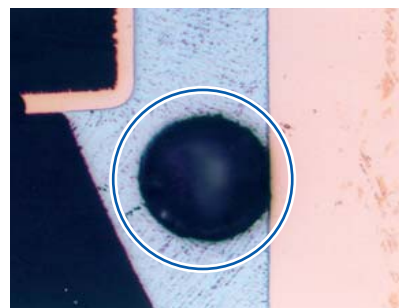

Picture 92: Heat from the lead is directly transferred

The void on the part contacting the lead has a high possibility of cracked solder due to heat from the lead that causes repeated expansion and contraction. It can be assumed that the land surface and the voids in the center of the solder are not affected due to heat dissipation.



Picture 93 (enlarged view of picture 91)

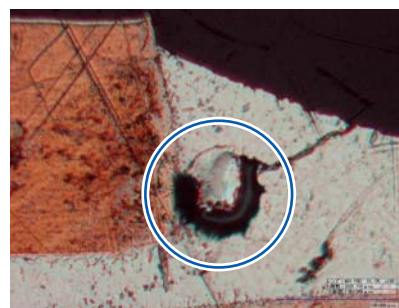

Picture 94 (enlarged view of picture 93)

(5) Side balls (on chip side)

Side balls are basically a problem related to the amount of printed solder. However with lead-free solder, the amount of printed solder should not be significantly reduced, as reductions have an effect on wettability. Instead, the ratio of the land to the opening in the solder mask should be over 100%.

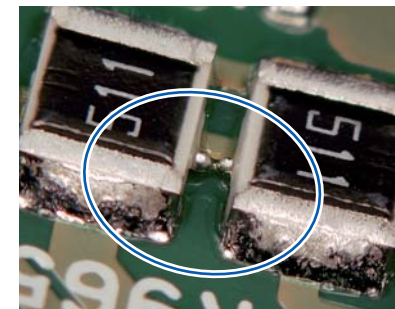

Picture 95: Side balls from too much printed solder



Picture 96: Image taken using a Rotary-Head Adapter (MX-5040RZ)
Side balls from excessive solder printing

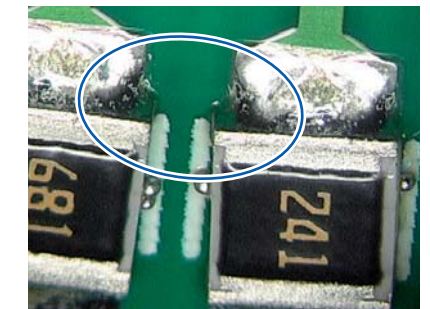

Picture 97: Solder balls from sudden wicking

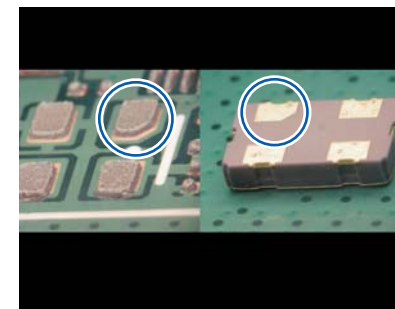

Picture 98

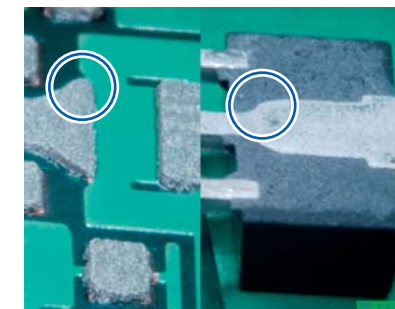

Picture 99

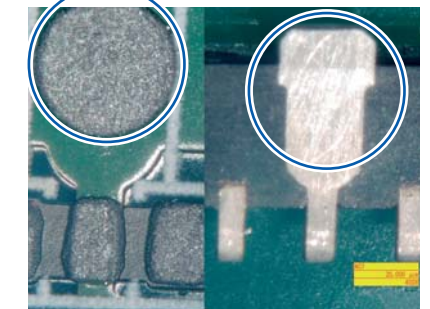

Picture 100

Solder balls caused by misalignment of the part lead surface and the land surface (design fault)



Picture 101: Solder wicking

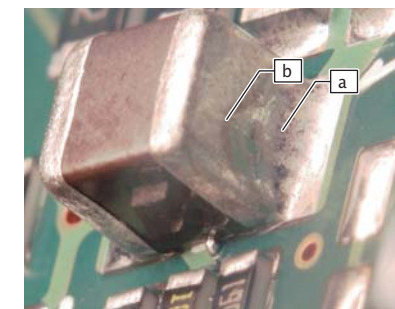

Picture 99: a. Solder wicking, b. Flux wicking

An incorrect profile can cause balls because the solder cannot wick up to the same place as the flux.

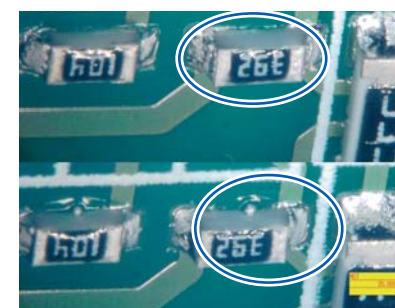

Picture 103

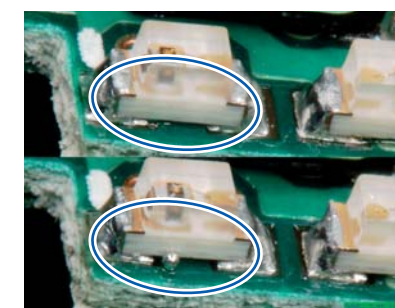

Picture 104

Instead of trying to resolve this by slowing down the conveyor belt, speeding up the belt helps prevent insufficient wicking.(Picture 103,104)

(6) 0402 chip mounting

Reducing the amount of printed solder also reduces the amount of flux and inhibits the melting of the solder. The amount of heat at the preheating stage must be controlled, especially with the 0402

chip. However, temperature cannot simply be reduced because there are other parts to be mounted.

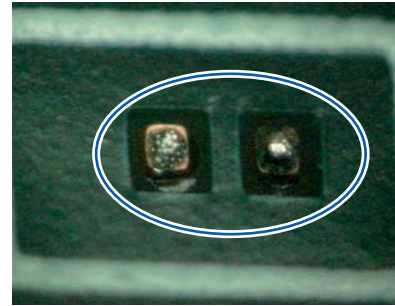

Picture 105: 0603 chip

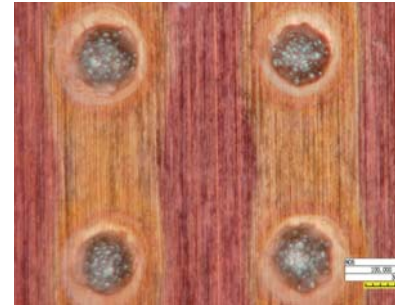

Picture 106: Ultra-fine particle solder

The solder on the left land of the 0603 chip did not melt because there was an insufficient amount. With the 0402, self-alignment works to correct misaligned mounts.



Picture 107: 0402 chip



Picture 108: 0402 chip

When simultaneously mounting parts with different amounts of solder and heat balances, a bottom side infrared heater can be used to provide heat directly to the circuit boards without having an effect on the parts on the bottom. The upper heater controls the melting of solder and prevents deterioration. Excluding special circumstances, the top temperature needed to melt solder is between 230 and 235 degrees Celsius.

(7) Compatibility with part leads

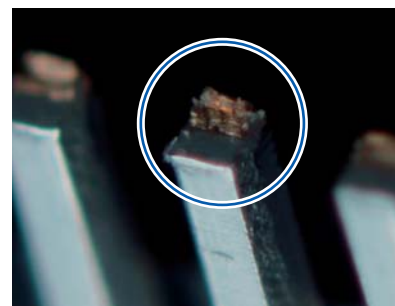

Picture 109



Picture 110

If the plating on the part lead tips is insufficient, bubbling solder will wick up between leads and create bridges.(Picture 111,112)

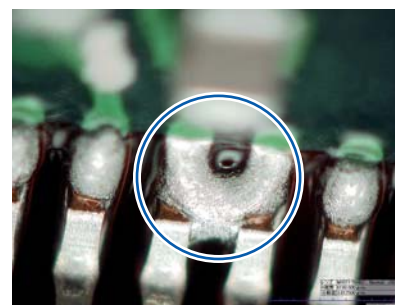

Picture 111

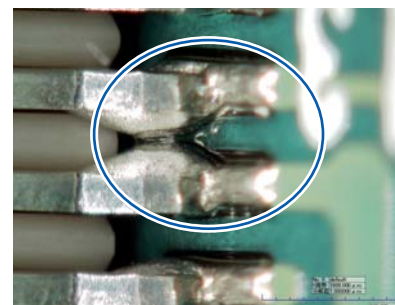

Picture 112

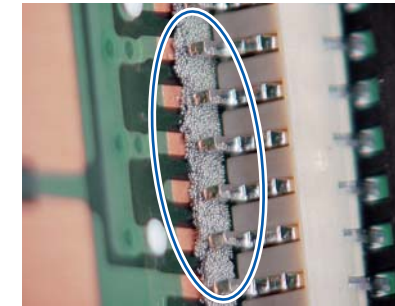

Picture 113

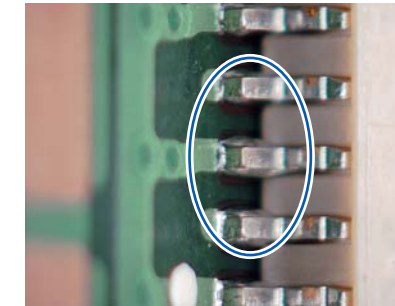

Picture 114

Solder is printed and reflowed on a straight joint so that it covers the resist deep on the lead. When solder wicks from the backs of sufficiently plated leads to the tips, wettability can be preserved even if the plating is not entirely adequate. If the temperature profile is appropriate, all solder of the resistant aggregate on the land.(Picture 115,116)

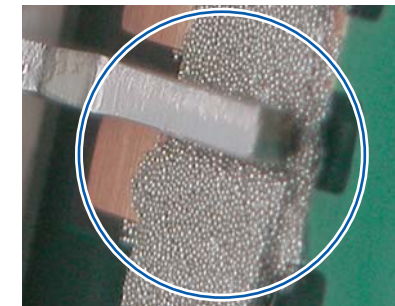

Picture 115



Picture 116

II.Flow

1) Angle of delivery

The biggest problem with lead-free flow can be seen on the mounting surface. The contact surface of the board and the solder is limited because the angle of the board on the belt is set at 5 degrees. This results in insufficient heat, which can be prevented by increasing the temperature of the solder pots. Although flux has already deteriorated during preheating, hot air is blown by the first jets. After deterioration, cooled solder with a reduced flow remelts in the second pot. The remaining flux then adjusts the fillet.

This is an irrational mounting method from the viewpoint of flux. The problems with this method are summarized below.

- The board delivery angle is too great
- Application of flux is not uniform
- Insufficient wetting from the through hole through all board layers
- Inappropriate land design

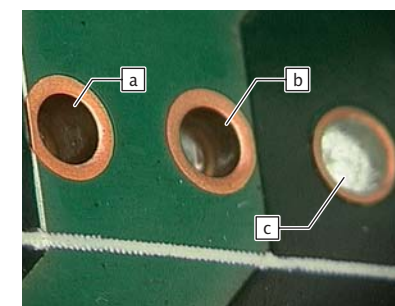

Picture 117

a indicates erroneous flux application
b indicates heat dissipation from a solid land
c indicates good wetting from the through hole

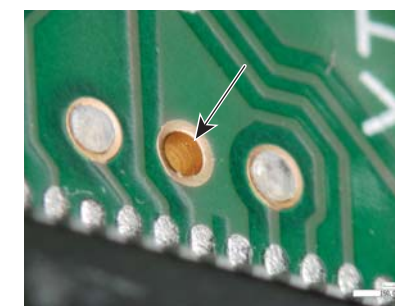

Picture 118

The hole in the center indicates poor wetting at the through hole due to insufficient heat as a result of heat dissipating from a solid land.

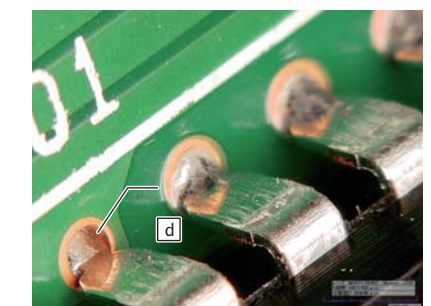

Picture 119

Wetting is poor only at this through hole where heat dissipated from a solid land.

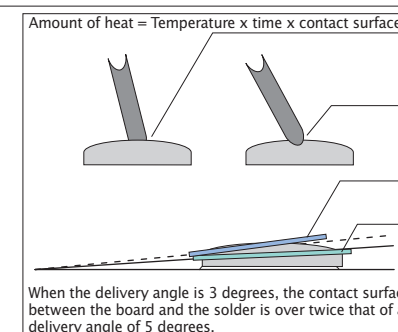

When the delivery angle is 3 degrees, break away time from the solder pots is slow and sufficient heat is supplied.

When the delivery angle is 5 degrees, insufficient heat causes the part lead to quickly break away from the solder pot.

Delivery angle of 5 degrees

Delivery angle of 3 degrees

When flux has been correctly supplied, the status of the applied solder changes by controlling the amount of heat.

Excessive heat =

- (1) Lead is too long
- (2) Temperature in the solder pot is too high
- (3) Speed of conveyer belt is too slow
- (4) Contact surface between the board and the solder is too large

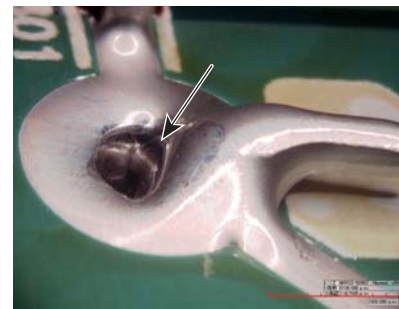

Picture 120

If the flux is effective, setting the delivery angle of the board to 3 degrees creates a large contact surface between the board and the solder. Supplying a large amount of heat without increasing the temperature in the solder pots improves the wetting at through holes through all layers of the board and reduces bridges. In order to stop flux from softening and flowing in response to heat, the ability of flux to flow from the solder pot to the board must be maintained. Solder balls break away with excessive heat, and a lack of heat controls solder flow and hardens the balls. (Picture 120,121)



Picture 121

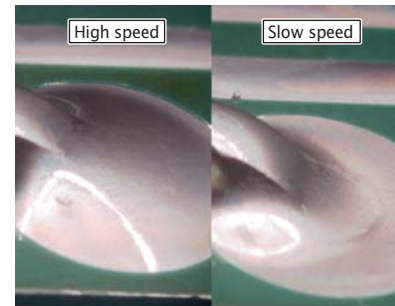

Picture 122



Picture 123: Normal state of applied solder

With normal flow solder, a large amount of heat causes dendrite formation and shrinkage cavities. (Picture 123) If the conditions are good, lead-free solder will not produce shrinking cavities. Setting the conveyor belt speed over 1.7 m/minute alleviates the problems of shrinkage cavities and dendrite formation. This depends on the abilities of onsite personnel. (Picture 124,125)



Picture 124

8-layer board with solid lands, temperature below 250 degrees and an immersion time of less than 5 seconds
Solder wetting to the top of the lead and shrinkage cavities, no dendrite formation



Picture 125

(Courtesy of Kouei Electric)

2) Faulty designs

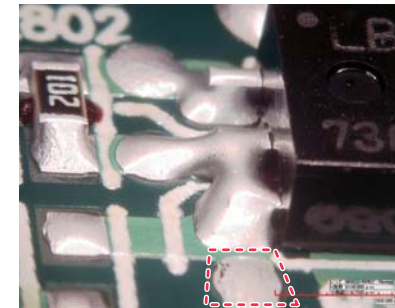

Picture 126

Unused lands as shown in the red box, can lead to bridges.

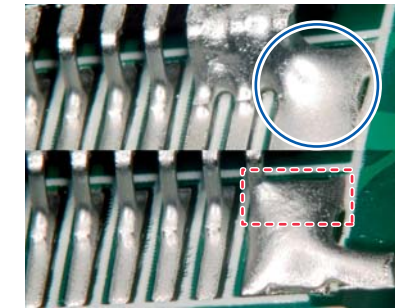

Picture 127

The highest point of the solder is far from the land as shown in the red box.

Unused lands from mistakes in the design can often lead to bridges. With square unused lands, the edges of wetted solder becomes a bridge between leads. This problem can be alleviated by changing the roundness of the solder so the highest point is separated from the lead.

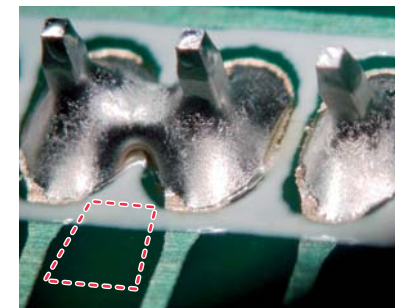

Picture 128

The red box indicates the position of the unused land

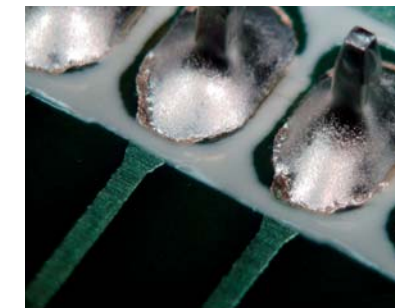

Picture 129

Example of a solution using flux for lead solder and a faster conveyor belt.

Bridges caused by board warping can be prevented by increasing the speed of the conveyor belt so the solder concentrates around the center of the connector lead. In this situation, switch to regular lead-solder flux if the reaction of flux cannot be controlled.

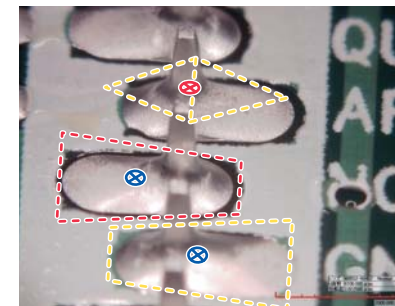

Picture 130

- (1) Place the unused land so that the center of the land is further separated from the lead and behind the flow of the board to eliminate bridges caused by solder surface tension.
- (2) Design so the solder concentrates around one point of the lead.

3) Flow temperature profile measurement points

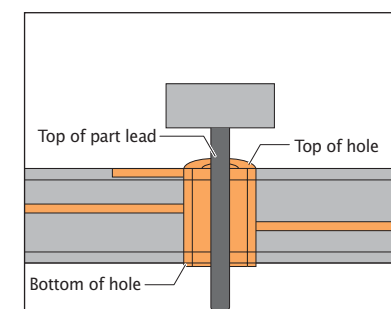

Temperature

- (1) Temperature at the top of the hole should be higher than the solder melting point.
- (2) If the temperature at the top of the lead is higher than the melting point of the solder, the fillet becomes higher.
- (3) The larger the bottom of the land is, the easier it is to transfer heat.
- (4) A smaller land at the top of the hole controls heat dissipation more effectively.

Roundness at the through hole requires both the temperature at the top of the hole to be higher than the solder melting point and the presence of effective flux. With sufficient heat and appropriate flux, solder wicks up to the top of the lead. Lead-free solder will have a gloss similar to that of eutectic solder.

III. Rework and repair

1) Shiny solder joint

The most important points to consider when using wire solder are the tip shape of the soldering iron, the plating of the tip and the process of adding solder.

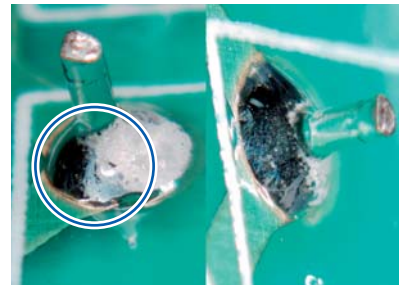

Picture 131

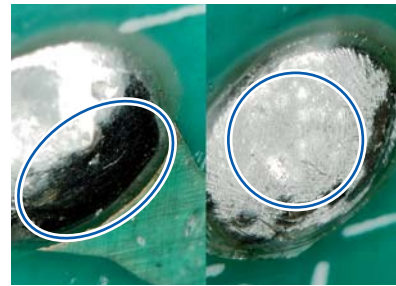

Picture 132

Picture 131: A good, shiny solder joint resulting from even heat dissipation on the land.
The picture on the right shows dendrite formation due to slow cooling.
Picture 132: A glossy fillet only on the land is a result of rapid cooling of the land.

2) Soldering iron tip shape

Heat balance has a major impact on land pattern design during reflow and hand soldering with wire solder. The inner levels of multi-layer boards may experience problems related to either heat dissipation or heat absorption.

These issues are easily managed in reflow by the use of infrared heat. However, manual soldering requires work to be done rapidly in order to provide enough heat to the area. Adding excessive heat causes potato-shaped solder joints and insufficient wetting because of flux deterioration and the majority of the heat taking a long time to pass through the land pattern and in to the board. A basic rule for both reflow and manual soldering is the application of solder at high temperature for a short period of time to parts with low heat resistance.

The objective with parts that require high heat is to solder before the flux becomes ineffective by quickly providing the necessary heat to the specific point before the heat dissipates when removing the tip of the soldering gun while the land and the lead are in full contact. The process must be carried out while flux is activated on the soldering surface in order to prevent oxidation.

Wire solder is perfect for manual application on stainless steel in industrial applications. The proper shape and width of the soldering tip making contact with the land are important points to consider. With some exclusions, it is the board that requires ample heat rather than the parts.

This is the same in soldering for repair of BGA as well. Repairs can be conducted easily and neatly eliminating preheat and only using the heat from a soldering iron.



Picture 133: Insufficient through hole wetting

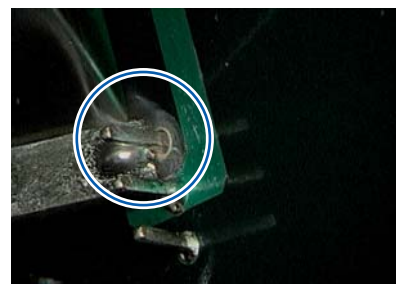

Picture 134: Forked soldering tip

Solder does not wet to the inside of a through hole using a normal tip. Using a forked tip makes application of solder easy providing sufficient heat to form a micro dip well around the tip of the soldering iron. Because heat resistance of wire solder flux is high, failure to work with a tip that is equal to or below temperature recommendation will lead to poor solder joint quality.

Solder is applied with heat.
Amount of heat = Temperature x time x contact surface

Solder does not melt even with a soldering iron tip at 380 degrees. Solder melts immediately at 320 degrees with a 'C' cut or forked soldering tip. (Pictures 136, 137)



Picture 135: Good wetting with a multi-layer board

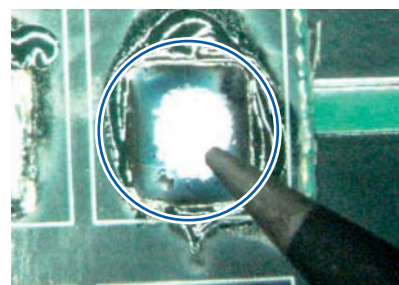

Picture 136



Picture 137

Although the shape and plating of the soldering iron tip are important, excessive heat can reverse the effects.

3) Repair



Picture 138: Insufficient through hole wetting



Picture 139: Lead surface is good

Through hole corrections cannot be made by adding solder on to the part surface because the added and old solder in the hole may not melt together. Solder wets to the part surface by providing additional flux on to the part surface and applying heat using a forked tip iron from the lead side to melt the solder.

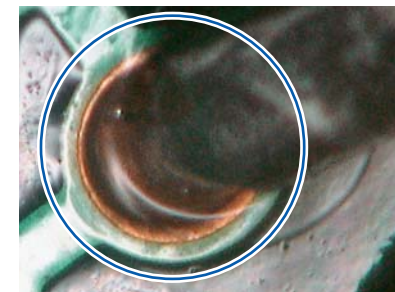

Picture 140: Providing additional flux to the part surface

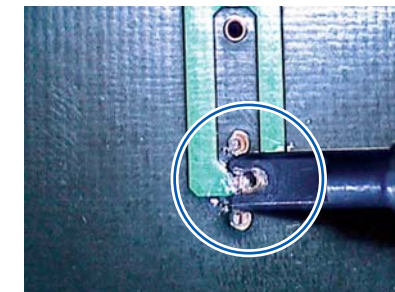

Picture 141: Re-apply heat to the lead surface



Picture 142 (enlarged view of picture 141)

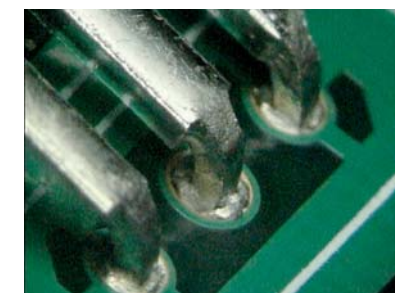

Picture 143: Observation of solder wetting on the part surface

4) Defects due to insufficient soldering leaving a residue of poorly activated flux



Picture 144

Air bubbles are visible in the residual flux because the soldering iron tip was too small to provide sufficient heat. A void is likely in the through hole.



Picture 145



Picture 146 (enlarged view of picture 145)

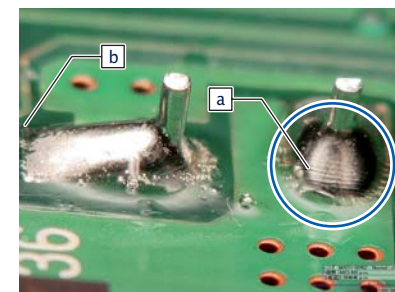

Picture 147

Differences in fillets created when applying solder numerous times with a small soldering iron tip to a large land.



Picture 148 (enlarged view of "a" from picture 147)

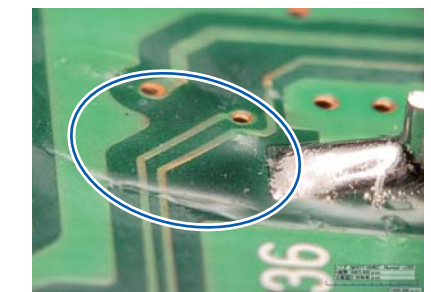

Picture 149 (enlarged view of "b" from picture 147)

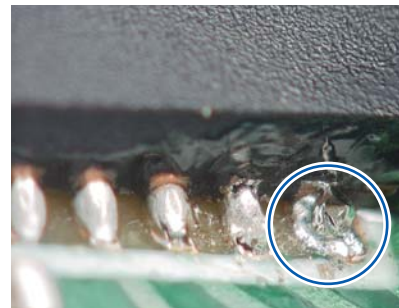

Picture 150: Errors that occurred during rework.

Although a technician performed the tasks, the work has not been checked carefully.

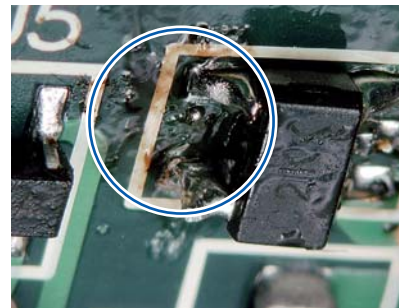

Picture 151: Solder balls that dropped from the soldering iron tip and burned residual flux

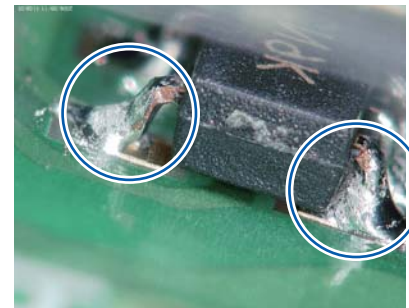

Picture 152: Solder joint on the left side indicates soldering with residual solder remaining on the soldering iron while the solder joint on the right side shows outcome with a clean soldering iron.

IV. Inspection Process

1) Observation points and remedies

(1) Voids and blowholes



Picture 153: The small bubbles on the side of the fillet indicate the possibility of a void in the hole.



Picture 154

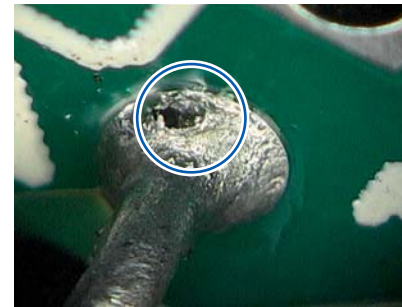

Picture 155: Blowhole

(2) Land stripping



Picture 156: High solder well temperature causes land stripping

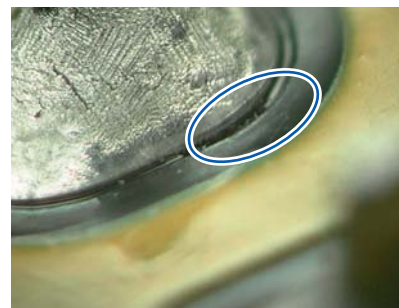

Picture 157: The land is not stripped, but there is residual flux.



Picture 158

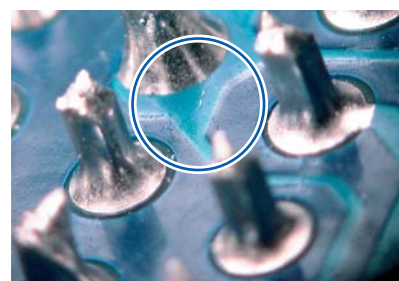

Picture 159: No land stripping



Picture 160: Land stripping and residual flux are visible on the bottom of the fillet.

The Hirox KH-7700 digital microscope allows for observation of halation by rotating the lens to change the angle of observation. This method can be used to check the status of residual flux. (MXG-5040RZ lens) In this case, the presence or absence of residual flux also indicates the presence of absence of land stripping.

2) Observation angle



Picture 161: Insufficient hole wetting



Picture 162: Forked soldering iron tip

With the Hirox KH-7700 digital microscope, you can rotate the lens to change the angle of observation and acquire a different view of the same point. (Pictures 162) This rotation also causes the lighting effect to change. (Pictures 161)



Picture 163: Good wetting even on 4-layer boards

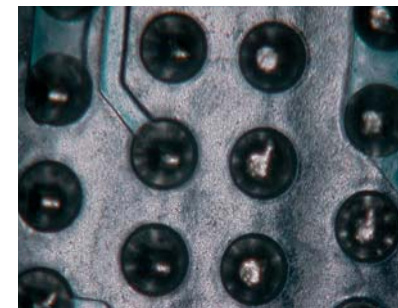

Picture 164: Re-applied heat from the lead surface

Changing the angle of observation gives a different view of the same land. (Pictures 163 and 164)

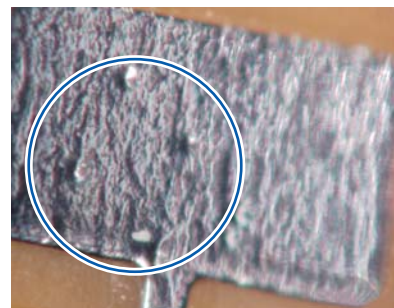

Picture 165 (enlarged view of picture 141)

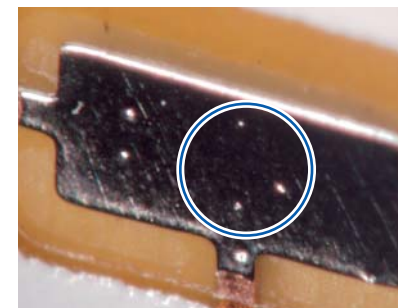

Picture 166: Observing solder wetting from the part surface

The ability to change the angle of observation is extremely important for complete observation. This allows for different views of the same land surface.

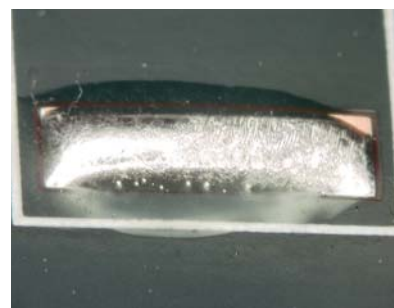

Picture 167

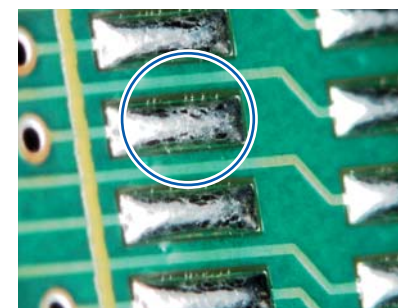

Picture 168

The holes in the side of the land indicate that a long preheating phase caused solder particles to oxidize. The result is unmelted solder balls that lost fluidity due to flux deterioration and were not attracted to the fillet. This problem can be solved by shortening the preheating phase.

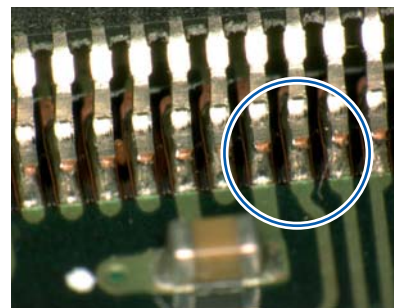

Picture 169

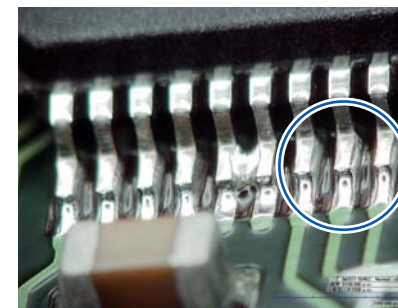

Picture 170: Sample from Picture 169 observed through KH-7700

Although boards are normally judged by observing the condition of residual flux, most observation equipment lacks a powerful light source to show the differences. The KH-7700 Hirox digital microscope uses a metal-halide lamp that is very bright and provides numerous lighting options.



Picture 171: Sample from Picture 171 observed through KH-7700

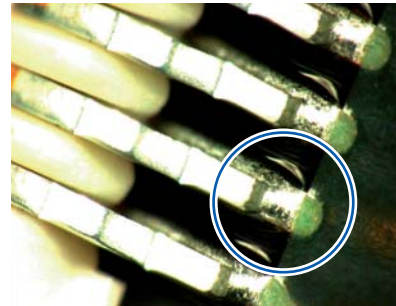

Picture 172

Changing the angle of observation and the lighting during observation allows the checking of residual flux and joints. In picture 172, the lighting and the angle of observation do not show the true picture.

3) Observation of whiskers

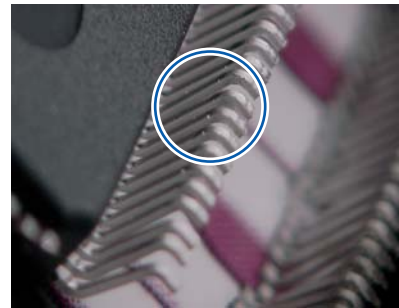

Picture 173



Picture 174

Rotating the lens and recording video, functions both available with the Hirox KH-7700 digital microscope, enhances observation. Normally, observations are made by first specifying an area for observation with optical equipment and then using a SEM, especially when observing whiskers. Microscopes that can observe the leads deep on the board while recording video are extremely important tools for observation.

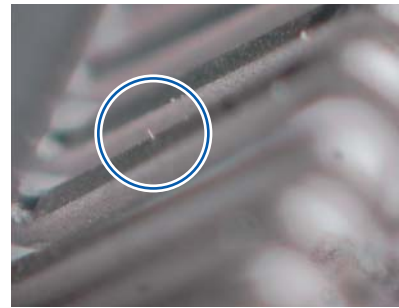

Picture 175

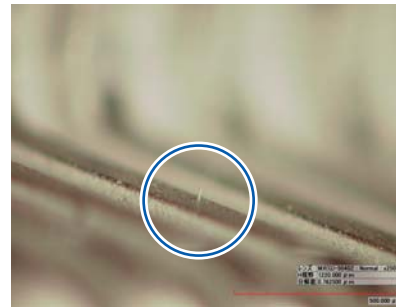

Picture 176

4) Other problems

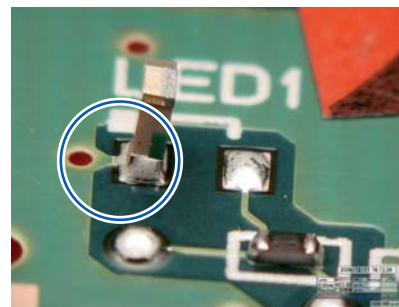

Picture 177

Lifted chips are a problem of design.

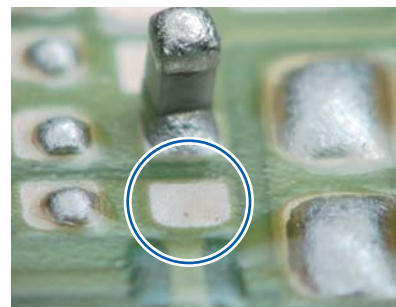

Picture 178

Oxidation of the lands causes lifted chips.

Picture 177 shows a defect where heat from solid lands and holes caused the left side of the chip to melt first. Picture 178 shows a defect where the bottom land oxidized and repelled the solder.

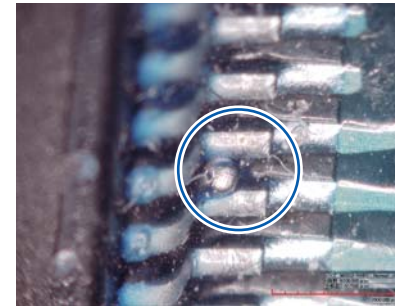

Picture 179

Lifted chips are a problem of design.

During corrective work, solder fell from the tip of the soldering iron and remained as a ball because of the flux.

V. Design

Below are pictures of a working 15 year old TV that we took apart. The parts repaired by hand, using lead solder, were not significantly affected by heat. Yet the repairs are of poor quality. Moreover, although the QFP flow is problematic, they too have not been affected by heat. However, parts that have been affected by heat are clearly broken.

Looking at break downs in recent electronics, many are related to soldering. Most of these products were 10 years old and out of warranty.

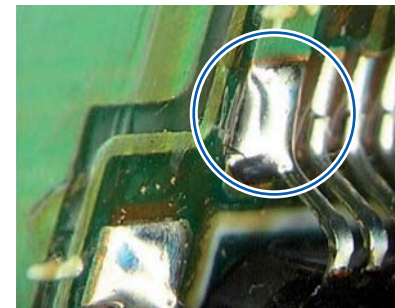

Picture 180

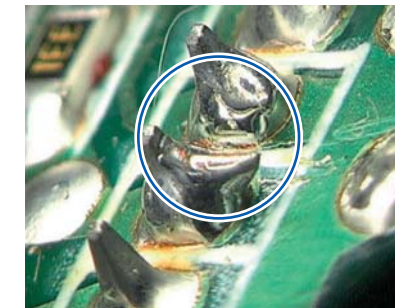

Picture 181

It is better, from a business perspective, for future design to be focused not on unreasonably extending the life of a product, but on making sure that defects appear during a prescribed period of time. There is a difference between defects and break downs.

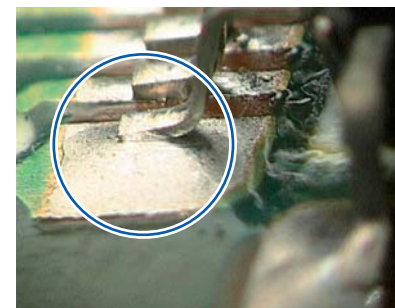

Picture 182

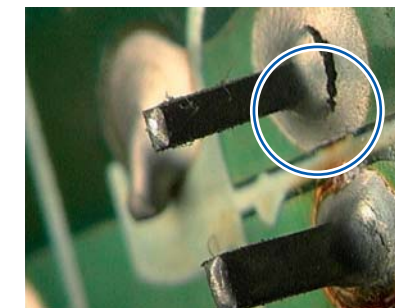

Picture 183



Picture 184

Summary

On circuit boards, flux reacts the quickest to heat. Therefore, observations made at the factory should look at the condition of residual flux to analyze and judge the balance of heat. This is the easiest way to eliminate defects.

Finding and fixing defects at the end of or after the whole process is too late. It is better to have the factory personnel curb problems by making an initial analysis before and immediately after reflow. Compared with leaded reflow soldering, failure ratio of lead-free reflow soldering is reduced rather quickly to 10 ppm or less. The point lies in the separate usage of upper and lower heaters that can create temperature differences to match the characteristics of flux and the movement of heat. In an oven that uses both far infrared and air heaters, the upper heater provides enough heat to melt the solder while the far infrared acts like a floor heater, providing even more heat directly to the board from the bottom. This prevents the deterioration of flux and allows parts with different

heat capacities to be mounted simultaneously.

This is possible even with small reflow ovens by adjusting the speed of the conveyor belt. Larger ovens require faster belt speeds and therefore hot air blows between the components, preventing proper heat balance. This is especially true in the preheat stage, where fans accelerate the rapid deterioration of flux and oxidation of solder particles.

Adjusting the profile to flux, this problem is solved on most machinery by adjusting the speed of the conveyor belt. This reduces the switching time for machines.

Soldering using flux that reacts quickly to heat curbs the impact of heat on the parts and board. At the same time, it also solves the problems of voids and spattering.

Because excessive heat causes flux to deteriorate, flux deterioration must be prevented in the preheat stage until the solder melts.

Material sources

Kojima Solder
Yuyama Co. Ltd.
Kouei Electric
Nippon Antom Co., Ltd.
Edsyn International Co., Ltd.
Hirox Corporation

Photographic equipment

Digital Microscope
Hirox KH-7700/KH-1300
<http://www.hirox.com>



SEIKA

East Meets West

Advanced SMT Solutions for Electronics Assembly

As a multinational distributor, SEIKA has a strong reputation for providing high-performance and quality SMT solutions at cost-effective pricing. We even provide every product with full technical support, installation, and engineering services.

Our reputation along with our partners is solid in Asia and Japan, and now it's time the West discovers what the East already knows – our advanced machinery and materials for the electronics industry.

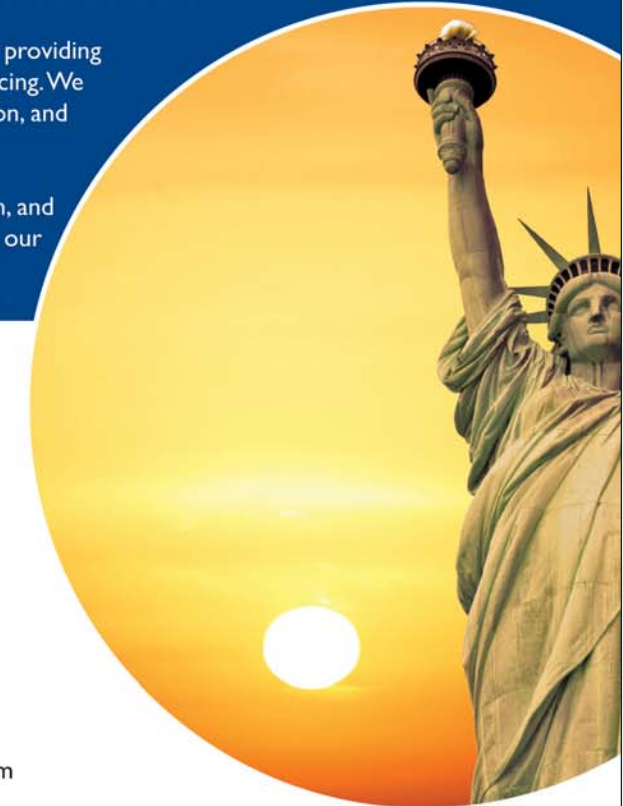

Sayaka PCB Router

- Low stress depanelization
- Easy software programming



McDry Dry Cabinets

- Store MSDs safely without nitrogen
- Conforms to IPC/JEDEC J-STD 033b.1



Hioki Flying Probe Tester

- High-speed, fixture-less testing
- Fine pitch probing capability of 0.2mm



Hirox Digital Microscopes

- Inspect objects in 360° with patented Hirox design
- BGA, QFP, cross section inspection with measurement



Anritsu 3D Laser Solder Paste Inspection Machine

- High-speed, ultra-high resolution
- Easy programming, auto calibration



Young Jin Conveyors

- Patented magnetic roller mechanism limits stress on PCB's during transfer
- Safety covers with interlocked doors



Visit us at www.seikausa.com to see more of our products!

Los Angeles Office:
3528 Torrance Blvd., Suite 100
Torrance, CA 90503

Atlanta Office:
3030 Business Park Drive, #3030-B
Norcross, GA 30071

Phone: (310) 540-7310 Fax: (310) 540-7930 Phone: (770) 446-3116 Fax: (770) 446-3118