



DIGITAL MICROSCOPE **KH-1300**

Hirox Co.,Ltd. <http://www.hirox.com>
2-15-17 Koenji Minami,Suginami-Ku,Tokyo166-0003,Japan
Tel:(+81) 3-3311-9911 Fax:(+81) 3-3311-7722
E-mail:tokyo@hirox.com

Hirox-USA, Inc. <http://www.hirox-usa.com>
1060 Main Street,River Edge,NJ 07661
Tel:(201)342-2600 Fax:(201) 342-7322
Toll-Free:(866)HIROX-US E-mail:inquiry@hirox-usa.com

Hirox China Co.,Ltd. <http://www.hirox.com.cn>
220 Han Dan Road Yi-Fu Bldg,Suite 309,Shanghai 200433,China
Tel:(86-21)6564-7772 Fax:(86-21)6565-1151
E-mail:jjyao@hirox.com

Hirox Korea Co.,Ltd. <http://www.hiroxkorea.com>
#603 Acropolace Bldg,1594 Burim-Dong,Dongan-Gu,Anyang-City,
Kyunggi-Do,Korea Tel:(82-31)385-1130 Fax:(82-31)385-9730
E-mail:bkim@hiroxkorea.com

For more information, contact Hirox or your authorized dealer.

The specifications and design of this product described herein are subject to change without notice for modification or other reasons.
PHPO-0609-C720



Breathtaking beauty, starting inspections all over again

Analog RGB connection realizes monitor output of 24 frames per second for first time among same-class microscopes

Largest image output among UXGA monitors of 24fps realizes genuine video inspection.

Equipped with IEEE1394.b for the first time in industry, this microscope is capable of transferring high resolution moving image of 15 frames per second to PCs

This microscope realizes video inspection on PC screens for the first time among same-class products. Use of next-generation high-speed serial bus IEEE1394.b enables high-speed transmission.

DIGITAL MICROSCOPE KH-1300



Newly developed CCD

Image that transcends the boundaries of digital expressions

Heart-moving world of microscope image

CCD camera is designed from scratch to fit lens for KH-1300.

2.11-million-pixel digital CCD camera was newly developed to reproduce natural colors, to create rich, desired images. The microscope succeeds in realizing the highest frame speeds--RGB output of 24 fps and IEEE output of 15 fps--and high resolution, rich color gradation and high-quality image at the same time. Also, for better color reproduction, the microscope uses RGB filters that are coupled with newly designed low-pass filters for high-quality image.

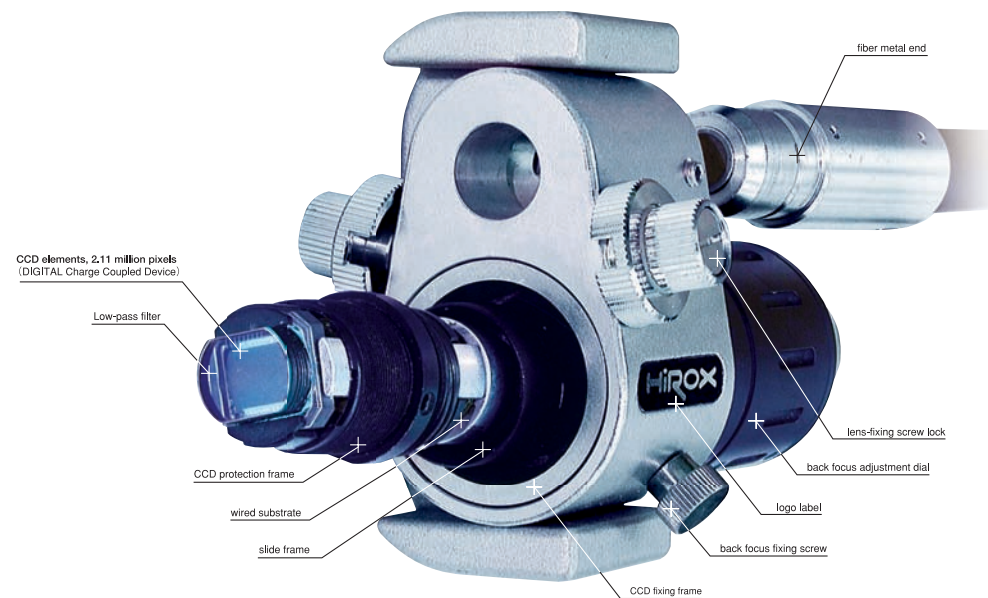

detachable fiber adaptor
With detachable fiber, various illumination can be applied
 Back focus was designed from scratch to fit newly developed CCD, resulting in further convenience. Focus lock can be released by loosening screw so that various types of lenses can be used. By adjusting indexes, default conditions can be easily recovered.

low-pass filter
 Passes low frequency and cuts off high frequencies on the opposite end of spectrum. Reduces image deterioration called moir_ and creates beautiful images

RGB24FPS

Sharp image output on large UXGA (1600 x 1200) monitor

Advantage of analog RGB output of 24 frames per second

"Real" image in true sense.

Wiring circuits were newly developed to improve frame rate to accommodate high resolution, high image quality. Achieves direct transmission speed of 24 fps, a landmark for digital microscopes equipped with 2 megapixel CCD camera, as a result of reviews of all parts and the development of new technology for transmitting high frequency data at a certain rate. With 24fps transmission, smooth moving images, in other words real-time images, are produced. Enlarged inspections are possible without causing stresses on the operator when the operator adjusts focus, zooms in or out and moves samples. The operator may even feel uncomfortable or sees limits in observations when looking at moving images that cause stresses. The strength of this microscope can be felt when observing samples that change themselves with the passing of time. For real time observations, usability was sought after, resulting in this evolution.



High image quality, high-speed parts wiring circuit technology
Hirox's high-image circuit technology for supporting image production full of reality and high-speed transmission...

Advanced circuit technology plays an important role in producing high-speed, high-quality images. As a pioneer in microscopes, Hirox produces supreme images based on its knowhow and unique digital imaging technology.

Frame rate:
 Indicates how many times images are replaced per second to reproduce moving images. Unit is frame per second. In case of 24fps, image is produced 24 times in one second. Higher rate means smoother image displays.

IEEE1394.b

Interface that connects to the next generation.

Transmits high-resolution images thoroughly

Realizes high-speed transmission of 800 Mbps for the first time in industry. Capable of maximum 15 fps image observations on PC screen.

Next-generation interface IEEE1394 (※1) is seen to replace SCSI I/F as a high-speed hardware interface, with specified transmission speeds of 100 Mbps, 200 Mbps, 400 Mbps. KH-1300 introduces the so-called IEEE1394.a, which represents cutting-edge high-speed transmission technology. Equipped with IEEE1394.b that realizes transmission speed of 800 Mbps. KH-1300 is able to connect directly to desktop PCs and to produce high-resolution, high-volume moving image at maximum 15fps in a quick and secure manner, helping to create unconventional systems and new observation environment. (※2)
 For example, the microscope enables not only moving image observations on desktop PCs with a sense of reality, but also preservation of both still and moving images with simple operations. (※3) Various image-related software can also be utilized when playing stored images. (※4)
 Until now, microscopes have had various limitations even though they can be connected to PCs, and have been used chiefly for storing still images. With IEEE1394.b, the usability is improved and a system that can be applied to various scenes is guaranteed.

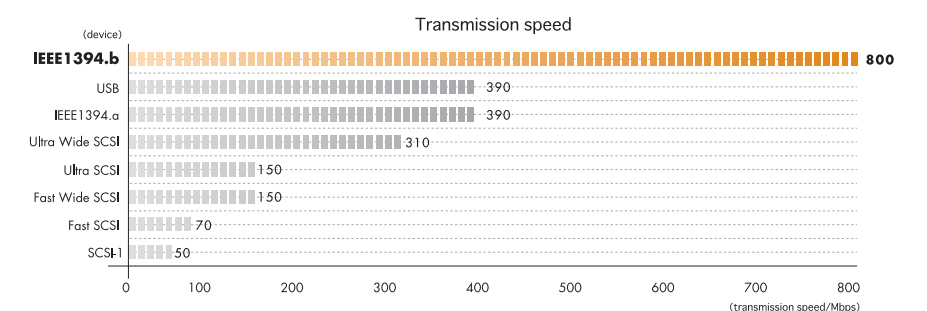

(※1) IEEE1394 (FireWire) was developed by Apple Computer Inc. of the United States and has become a standard for data transmission/communications and is a high-speed, easy-to-handle interface.
 (※2) Maximum display speed of 15fps on PC screens may not be achieved depending on CPU specifications.
 (※3) PC kit/IT-13b1 for KH-1300 and IEEE1394.b image input board/Zenkumaru/PFW-88 are required.
 (※4) Still image is saved as: TIFF, jpg, bmp/moving image as avi.



Dynamic macro functions

Wide contrast range helps thoroughly express various information contained in samples.

SNR

3D noise reduction processing realizes high dB. Even in high gain mode, clear image with little noise is produced.

masking functions

Independent variable masking functions in six colors reproduce colors faithfully with detailed information.

Selectable light sources

With abundant image production capabilities, the microscope performs superbly according to the environment.

Two selections that stimulate minds

Please pick lights that are best fit for purposes.

Metal Halide Lamp

To maximize sensitivity characters of the camera (dispersion characters/300nm-800nm), the visible light spectrum has to be covered on the side of light sources. In order to produce images of all samples thoroughly, metal halide lamp with high color reproduction capability detects samples that cannot be detected by other light sources. In addition, the lamp is able to last about six times the life of conventional products, a quality that makes it more accessible.

Halogen lamp

Because vaporized tungsten does not stick to walls and tubes, there occurs no reduction in the maintenance rate of light beams, which is usually caused by blackened glass bulbs, and the illumination level stays the same til the end. Also, a longer life of the lamp is realized by halogen cycles. It is a light source with stable results. It has been introduced in many cases at production sites with a relatively high frequency of use and other sections close to production lines and can be used under various environments.

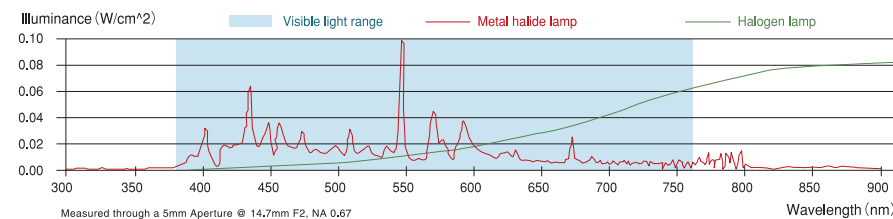

Light switch
On/off of light that can be applied for various observation scenes

In order not to influence samples, which, in turn, affect the light, and not to destroy inspection environment, the microscope is equipped with LIGHT switch independent of the main power source on the front panel.

Color rendering characters:
Judged based on color temperatures and color rendering index. Smaller the difference between how a color is seen under sunlight and how it is viewed under different lights, the better the color rendering quality of light sources.

Rotary head

Original observation technology supports enlarged inspections of all kinds

Reproduces things as they are

Hirox's lens and light adaptor produce visual reality.

Through 360-degree rotative prism, the microscope enables observations full of reality. Instead of tilting the lens, the microscope is easy to use, saves space and helps grasp the shape of an object freely through video inspections. It can be advantageous when a sample comes in a big size.

Image producing structure of rotary head

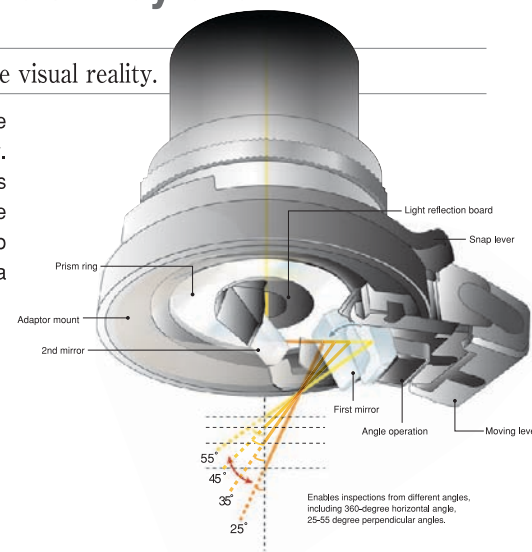
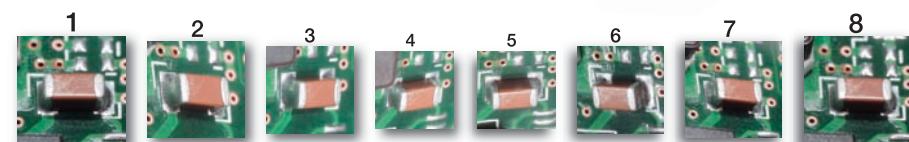
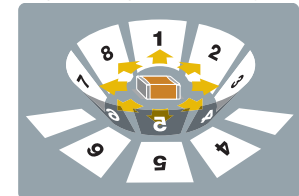

User mode setup

Unprecedented image quality and reasonable price

Realizes sought after images

Gets rid of troublesome operations. Adequately adjusted with switching volume.

Just as one picks observation angles, user mode offers selections of picture style according to samples User mode can be picked among 12 types of style to suit demands for vivid colors of samples and for images that have depth.

Metal structure

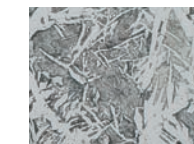

Basics

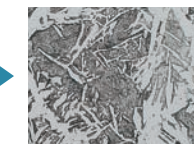

Emphasizing edges

Protein crystal

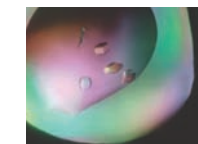

Basics



Strong color tones



Creative User mode setup born from imaging technology

In order to produce sought-after images, the user mode setup comprises technology for correcting the gap between voltage conversion values and elements, contrast setup that contains color information, enhance setup technology ranging from low to high frequencies and reflects image technologies accumulated through some 20 years as a microscope maker.

12 types of style
The microscope is able to produce images as wanted by the operator through underlining of edges, stronger color tones, or both at the same time.

Lens adaptor

Basic observations based on knowhows in optical technology

Illumination technology that offers light fit for each object

With easy operations, the microscope produces the image you want.

Light dispersion adaptor

Illuminations disperses light in all directions and is soft. It prevents halation of metal parts and reflection of strong lights.

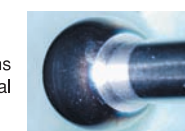

epi-illumination

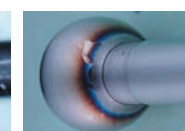

light dispersion

Light polarization adaptor

Inspections that take advantage of light polarization factors of samples. It removes surface reflections and creates colors on the distortions of resins that cannot be viewed under natural light, to allow observations.



color polarization

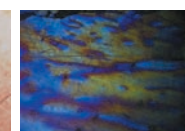

color polarization

Variable light adaptor

Light that changes angles from epi-illumination to continuous lighting from the side. The angle of the light is decided based on what are inspected, but an appropriate angle is obtained easily.



Side illumination (75 degrees)



Compound illumination



Epi-illumination (12 degrees)

Coaxial epi-illumination Coaxial, one-side light adaptor

One-side illumination functions were added to coaxial epi-illumination that enables clear observations. Enables three-dimensional inspections by underlining miniscule scratches and curves that are viewed with epi-illumination.



Side illumination

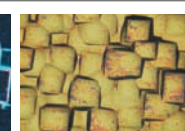

Coaxial epi-illumination

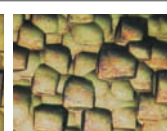

One-side, coaxial illumination

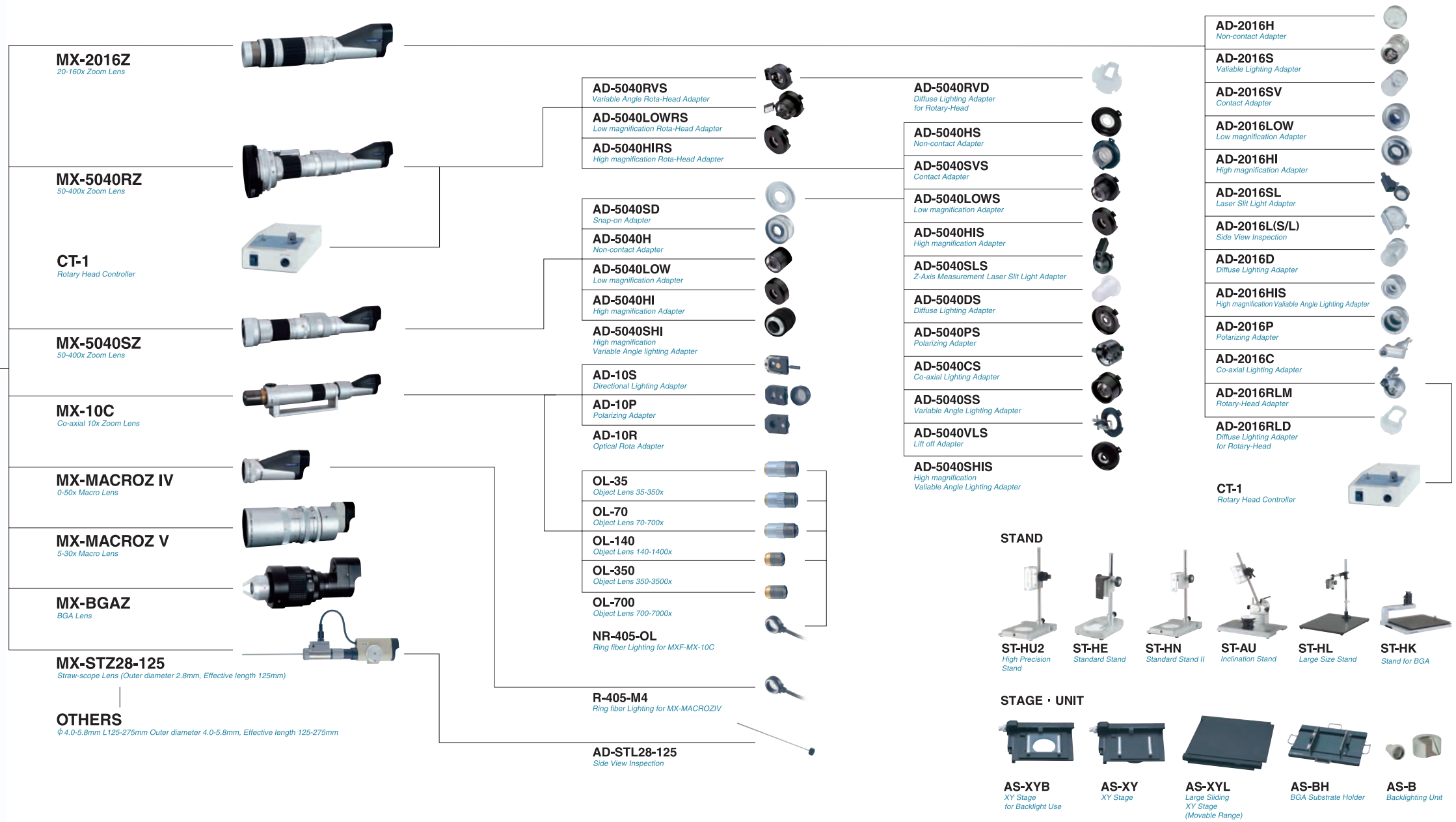

System configuration diagram

System 1

Analog RGB connection realizes UXGA (1600x1200) image output of 24fps

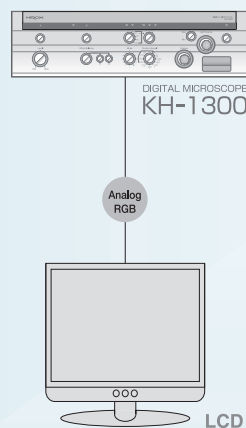

System 2

IEEE1394.b connection realizes UXGA(1600x1200) image output of 15fps at maximum on PC screens
※UXGA and 15fps output differ according to PC specifications

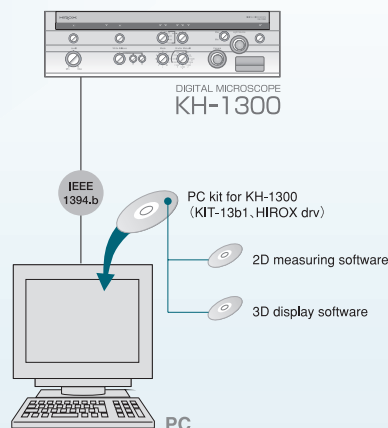

System 3

System 1+2 specifications
Enables simultaneous output at 2 monitors
※UXGA and 15fps output differ based on PC specifications

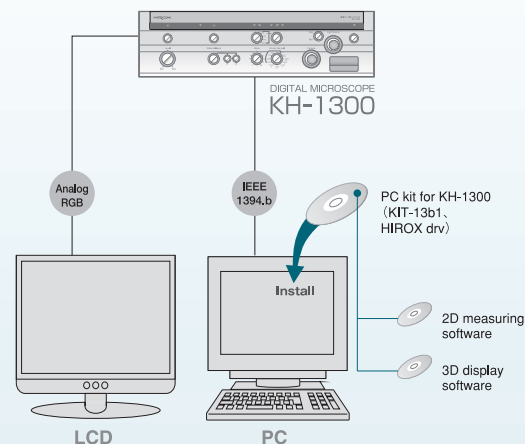

System 4

Electric XY stage control enables preservation of axis as well as image displays

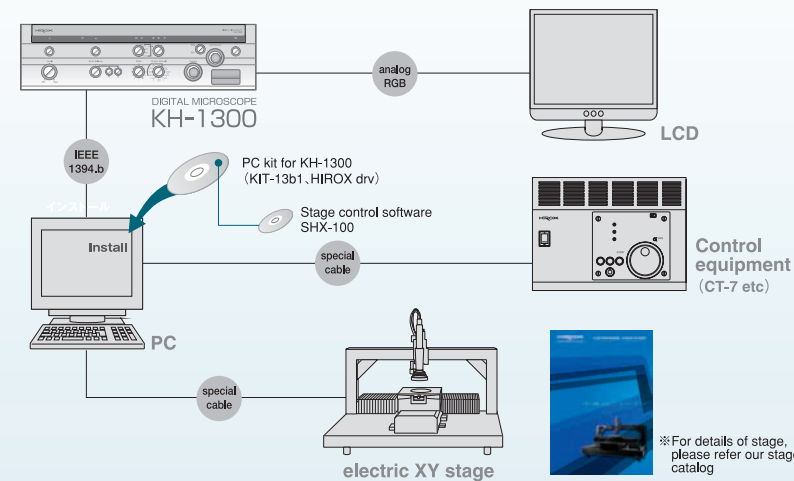

Specifications

shooting elements	1/1.8-model CCD
valid pixels	1628 (H) × 1236 (V)
frame rate	24f/s(analog RGB output)
white balance	MANUAL (R, B Gain) , One push AUTO
shutter	8, 4, 2, 1, 1/2, 1/4, 1/8, 1/24, 1/60, 1/100, 1/250, 1/500, 1/1000, 1/2000, 1/4000, 1/8000, 1/15000, AUTO
storage functions	Shutter-effective at 8, 4, 2, 1, 1/2, 1/4, 1/8
gain	AGC : 0dB~12dB Fixed: 0dB, 3dB, 6dB, 9dB, 12dB
RGB black	Brightness
gamma	ON/OFF Gamma characters (Common to RGB), trimming (independent of RGB)
User mode	12 stages(basic image setup values)
color bar	Exists (full field bar)
freeze functions	Analog RGB
power output Interface	Analog RGB · IEEE1394.b
operating environment	Temperature: 5-40 degrees, humidity: Less than 60 %
storing environment	Temperature: 5-40 degrees, humidity: Less than 60 %
power source	AC90~120V
size, weight	330(w)×130(H)×305(D) Main body 3.8 kg

Sample image

Appropriate inspection

Technology realized through balance between lens and light

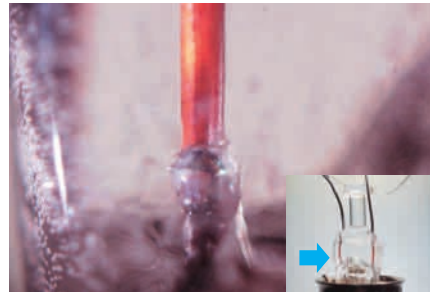

Vacuum electrode connection parts
MX-2016Z+AD-2016C+diascopic stand 80power

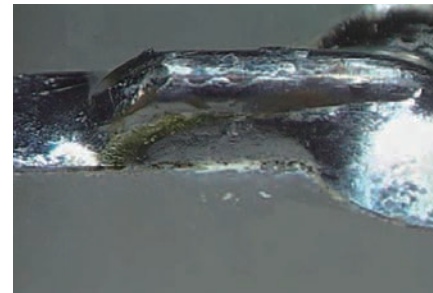

Land peel-off(Pb free)
MX-5040RZ+AD-5040VLS+lighting stand 100power

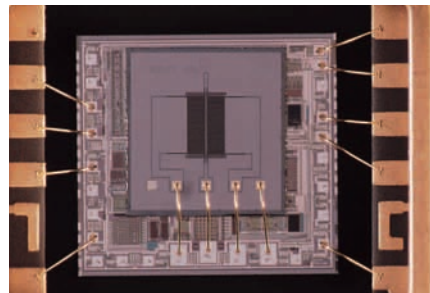

IC chip
MX-10C+OL-350+stand 350power

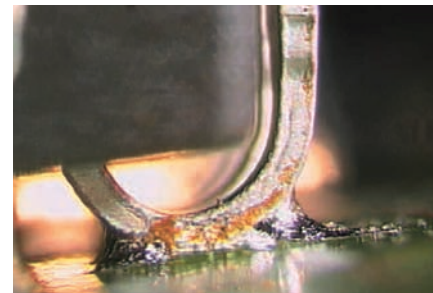

Solder connection surface
MX-2016Z+AD-2016LOW+stand 50power

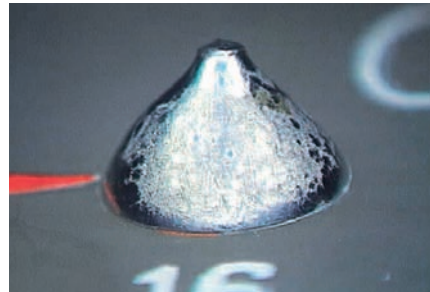

Excessive soldering
MX-2016Z+AD-2016RLM+stand 80power

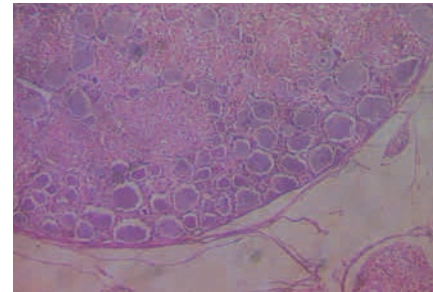

Spinal cord nerves of money
MX-10C+OL-70+diascopic stand 260power

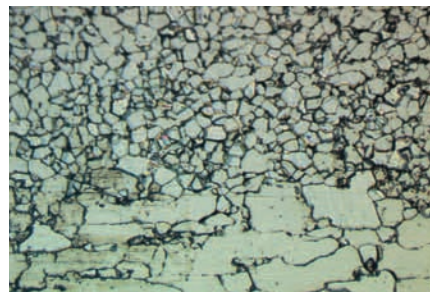

Metal structure
MX-10C+OL-140+stand 1000power

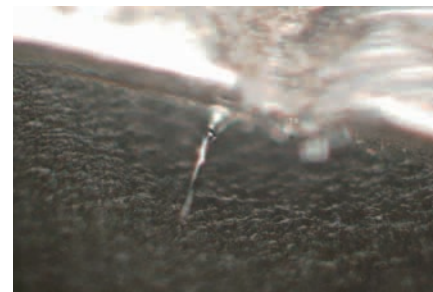

Whisker
MX-5040RZ+AD-5040RVS+stand 300power



BGA
MX-BGAZ+special stand 100power

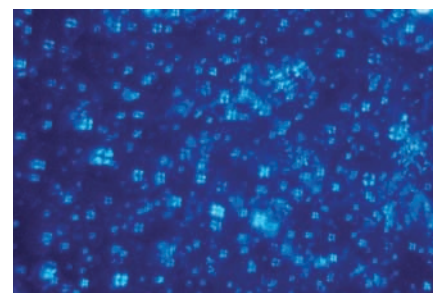

Liposome
MX-10C+OL-350+diascopic polarization light illumination stand 700power

Application Software

IEEE1394.b picture software (KIT-13b1)

2megapixel images taken by KH-1300 are sent at high-speed rate of 800 Mbps to PCs via IEEE1394.b cable. Enables live video inspection of maximum 15 fps, as well as preservation of still image and moving image.

※Optional setup: needs PC kit/KIT-13b1 for KH-1300 and IEEE1394.b image input board/ZenkumanPFW-86. Maximum display speed of 15fps on PC screens may not be realized depending on CPU specifications.

Still and moving image storage

- VGA (640×480)
- XGA (1024×768)
- SXGA (1280×960)
- UXGA (1600×1200)



Setup menu

Allows detailed settings on display and saving methods for live Image, still image and moving image, as well as selections according to the performance of PCs. (Still image saved as: TIFF, jpg, bmp/moving Image as avi)

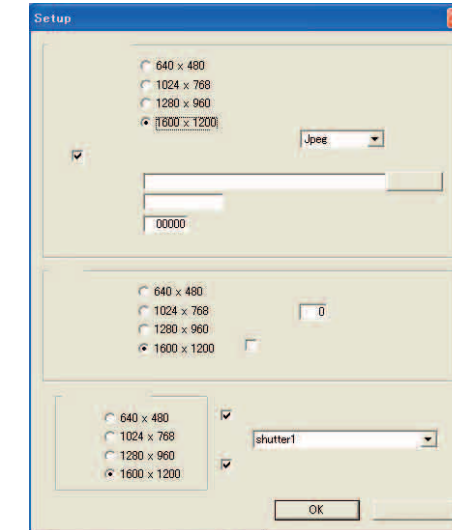

Easy operation due to tool bar

- One click of mouse allows switching between live image and free image. When the middle of camera is red, it indicates freeze. Blue indicates live situation.
- Click for saving live image or freeze image as still images. Allows images to be saved with ordinary file names but also enables consecutive data storage with consecutive clicks.
- Click for starting to store live image as moving image.
- Conditions of current displays are shown in a simple way. Four modes-- Live, Freeze, REC, Error-- are displayed

Abundant 2D measuring software

Allows various measurements on PC screens. Removes troublesome operations. Capable of high-precision measuring with the use of mouse.



3D display software

Several images stored in PCs are combined and displayed as 3D Image. Offers new inspection scenes with colorful expressions.

sample: single crystal (super conductor) 700 power

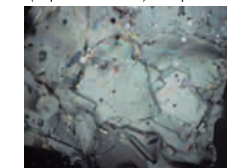

Profile composition

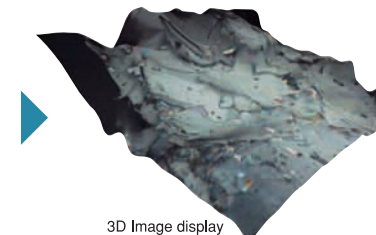

3D Image display

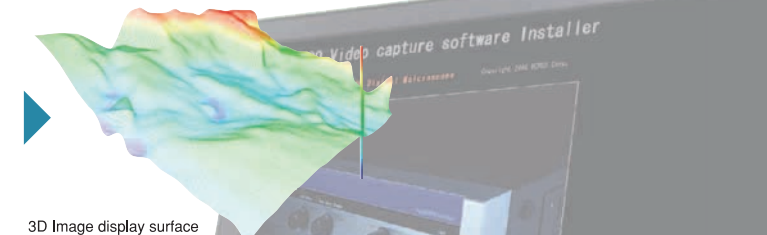

3D Image display surface

Stage control software (3 axial control)

Enables high-precision measurement and control by being almost united with the system.

- Measuring mode
- Fiducial alignment functions
- Starting point registration
- property sheet

